

CATALOGUE 2018



Verofer[®]

Cylinders and
Complements

 **BINALIA**[®]

Handles & Accessories



MADE IN EU



SC BINALIA SRL: at the beginning of the nineties of last century, Binalia was already working brass manufactures, and it was taken from a group of European entrepreneurs, who, in their original nations, praised solid experiences in the specific sector. Between these entrepreneurs there were persons engaged as much as in the production and in the marketing of those goods. The common research of new business opportunity was the glue for their different experiences. In that period the company knew a thorough renovation, and it was endowed of cutting edge machineries conducted by specialized technical. Beginning from the first years of the new millennium the company is the leading actor as much as corporate structures changes and a redefinition of its own core business: from a subject acting on behalf of third parties to a company with its own range of products for doors and windows, ranging over brass and other raw materials.

SC VEROFER SRL: Verofer was founded at the end of the nineties of last century, from a group of entrepreneurs both Romanians and Italians, who were able to count on the experience of Mr Vercellini, the majority shareholder, working from long time in the metal mechanical environment. He, and his staff, planned the diversification of the productions, adding to the traditional line of handles and locks even the line of security cylinders, to offer to the costumers a diversified fan of goods dedicated at the security of buildings. In the years, the productive flairs of Mr Vercellini have favored the emergence of synergies with European companies (leaders in the industry of doors and windows), which praise a specialization both in the realization of hinges for doors, anodized handles, high system of locks, and in the innovative sector of the sliding doors.

In the next months, the productive ways of Binalia and Verofer will join, to create an unique business reality able to purpose on the market as absolute protagonist in its sector.

Always paying attention to the requests of the costumers, we could better head the chance in the domestic and foreign market, combining the energy of the staff both of Verofer and Binalia.

The hallmark of our products is the full respect of the European standards of quality, security and design. It is no coincidence, for example, that our cylinders are completely realized in brass, with raw material certificate EN 10 204 2.2 and have implemented a quality system ISO 9001:2008.

A large range of our production is realized in brass, alloy of copper and zinc, which is easy to mold and hard proof to corrosion, while our manufactures in zamak respect the European standard as 410 EN1774 and are ermined with copper, which isolates and protects against corrosive agents.

Protagonists from years on the international market as well as on the Romanian market, for Binalia and Verofer, during their diversified production history, the respect of costumers has been their qualifying point. The companies succeeded by achieving productive performances, where the quality of production is combined with style and good functionality of the various range of goods which gives birth to the new catalogue we are pleased to present.



SC.Binalia SRL: Cu o prezență activă în domeniul producerii de articole din alama, Binalia a fost înființată la începutul anilor '90 ai secolului trecut de către un grup de antreprenori europeni care aveau deja avantajul unei experiențe solide, cu precădere în sectorul realizării produselor din alamă dar și în domeniul comercializării acestora.

Modalitatea optimă de a fructifica sinergia diverselor experiențe era aceea de a porni împreună spre căutarea unor noi oportunități de business.

În acea perioadă renaște o profundă restructurare a firmei prin implementarea unor tehnologii de avangardă puse în operă de un personal specializat.

În primii ani ai noului mileniu Binalia a cunoscut modificări atât în structura acționariatului dar mai ales și-a redefinit propriul core business trecând de la etapa în care realiza produse la cererea firmelor partenere la definirea unei game proprii de articole pentru uși și ferestre realizate atât din alamă cât și din zamac.

Pe parcursul următoarelor luni, Binalia și Verofer își vor unifica departamentele de producție, cu scopul de a da viață unei unice realități corporative capabilă să se impună pe piață ca un adevărat lider al branșei pe care activează.

Dintotdeauna atenți la exigențele clienților noștri și cumulând energiile partenerilor noștri strategici cu specializarea personalului tehnic provenit atât din Binalia cât și din Verofer vom putea înfrunța cu forță maximă provocările pe care ni le adresează piața indigenă dar și cea internațională.

Semnul distinctiv al produselor noastre îl constituie deplinul respect al standardelor europene de calitate, siguranță și design. Astfel în mod deosebit cilindri noștri sunt realizați în întregime din alamă, utilizând materie primă certificată EN 10 204 2.2 și având implementat un sistem de management al calității ISO 9001:2008.

Mare parte dintre produsele noastre sunt realizate din alamă, aliaj de cupru și zinc, ceea ce permite deopotrivă o prelucrare facilă și o rezistență crescută la coroziune, în timp ce articolele din zamac respecta normele europene 410 EN 1774 și sunt supuse unui tratament galvanic care le protejează de acțiunea agenților corozivi.

Prezente ca protagoniste atât pe piața internă dar și pe cea internațională, Binalia și Verofer - de-a lungul bogatei lor istorii productive - au transformat respectul față de client într-un element definitoriu, având ca scop atingerea unei performanțe productive prin care calitatea procesului de producție se combină cu stilul și funcționalitatea bogatei game de produse care au dat naștere acestui nou catalog pe care ne face plăcere să vi-l prezentăm.

SC Verofer SRL: Înființată la sfârșitul anilor '90 de un grup de investitori de origine italiană și română care au contat pe experiența lui Girolamo Vercellini, acționar majoritar, care a planificat diversificarea gamei de produse prin completarea gamei tradiționale de articole din alamă și zamac cu cilindri de siguranță, din preocuparea de a oferi clienței o gamă cât mai variată de articole dedicate siguranței clădirilor civile, comerciale și industriale.

Intuițiile productive ale lui Vercellini au favorizat de-a lungul timpului nașterea unor sinergii cu alte firme europene (lideri în sectorul de feronerie pentru uși și ferestre), în special italiene, specializate la rândul lor în producerea unor sisteme inovative de glisare, realizarea de balamale cilindrice, producerea manerelor din aluminiu anodizat etc.

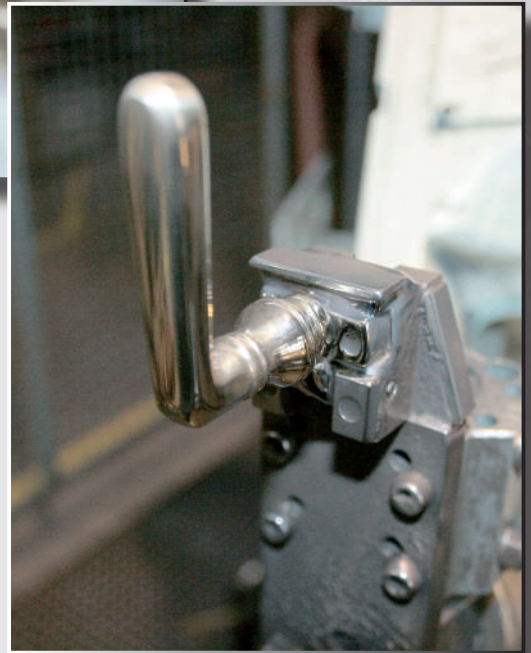



BRESCIA - ITALY

+39 0365 88052



ARAD - ROMANIA

+40 257 270 999



ARAD - ROMANIA

+40 257 289 734

BINALIA SRL has obtained the certification for conformity of Management System according to the UNI EN ISO 9001 : 2008

sc BINALIA SRL detine certificarea Sistemului de Management in conformitate standardul UNI EN ISO 9001 : 2008

Registration Certificate

This is to certify that the Management Systems of

SC BINALIA SRL

have been assessed by AJA Europe Ltd and registered against the requirements of

ISO 9001:2008

Certificate No. : **AJAEU/12/12731** Date of Original Registration : **31/05/2012**

Expiry Date : **11/05/2018** Date of Re-Registration : **18/05/2015**



Alfonso Pagliuca

Alfonso Pagliuca, Chief Executive, AJA Europe Ltd



This certificate is issued in respect of the locations & scope of registration detailed in the Associated Registration Schedule. This certificate is the property of AJA Europe Ltd Unit 6 Gordano Court Gordano Gate Business Park Serbert Close Portishead Bristol UK BS20 7FS and must be returned on request. A member of the AJA Group of Companies

Registration Schedule

SCOPE OF REGISTRATION

*Productie si comercializare produse din feronerie (din alama), inclusiv activitati aferente de proiectare.
Manufacture and sale of ironmongery (from brass), including related design activities.*

Company Name: **SC BINALIA SRL**
 Sites Registered: Str. 6 Vanatori, nr 51-53
 Localitate Arad
 judet Arad
 Romania
 Standard: **ISO 9001:2008**
 EAC: 17
 Date of Re-Registration: 18/05/2015
 Expiry Date: 11/05/2018
 Certificate Number: AJAEU/12/12731



Alfonso Pagliuca

Alfonso Pagliuca, Chief Executive, AJA Europe Ltd



This certificate is the property of AJA Europe Ltd Unit 6 Gordano Court Gordano Gate Business Park Serbert Close Portishead Bristol UK BS20 7FS and must be returned on request. A member of the AJA Group of Companies

BINALIA[®]
 Handles & Accessories

 **BINALIA**®



MATERIALS & FINISHING

BRASS

ZAMAK

STEEL



POLISHED BRASS
ALAMA LUCIOS

OLV

ZOL

OL



SATIN BRASS
ALAMA SATINAT

OSV

ZOS

OS



BRONZED BRASS
ALAMA BRONZAT

OBV

-

-



SCRATCHED BRONZE
BRONZAT GRAFIAT

OBG

ZBG

BZ



BRONZE MATT
BRONZAT MAT

OBM

-

-

NEW



ANTIQUE BRASS
ALAMA ANTIK

OBA

-

-



POLISHED CHROME
CROM LUCIOS

OCL

ZCL

CL



CHROME SATIN
CROM SATINAT

OCS

ZCS

CS



NICKEL SATIN
NICKEL SATINAT

ONS

ZNS

-



POLISHED STAINLESS STEEL
INOX LUCIOS

-

-

INOX



SATIN STAINLESS STEEL
INOX SATINAT

-

-

INOX SAT

ALLUMINIUM



ANODIZED SILVER
ANODIZAT ARGINTIU

F1



ANODIZED BRONZE
ANODIZAT BRONZAT

F4



SILVERED PAINT
VOPSIT ARGINTIU

F5



GOLDEN PAINT
VOPSIT AURIU

F6



WHITE
ALB

RAL 9016



BLACK
NEGRU

RAL 9005



BROWN
MARO

RAL 8022



NEW FINISHING

FROM NOW AVAILABLE FOR ALL THE RANGE BRASS LINE



WIEN

21292P - OBA

▶ page 38

BINALIA

ANTIQUE BRASS

ALAMA ANTIK

INDEX

Q - LINE SERIA Q

	CLIO	PAG. 17		MANHATTAN	PAG. 12
	DIANA	PAG. 14		MARY	PAG. 15
	ELISA	PAG. 13		NEW PRAGUE	PAG. 16
	GIUSSY	PAG. 16		VITTORIA	PAG. 17

BRASS LINE SERIA ALAMA

	ALICANTE	PAG. 21		LYUBA	PAG. 46
	ALT WIEN	PAG. 37		MADEIRA	PAG. 21
	ALTEA	PAG. 20		MAURA	PAG. 26
	AMBRA	PAG. 34		NINFEA	PAG. 31
	ATENA	PAG. 35		ONDA	PAG. 28
	BETA	PAG. 41		PANDA	PAG. 42
	CLAUDIA	PAG. 40		PAPERINO	PAG. 46
	COMBI	PAG. 46		SIMONA	PAG. 45
	COSMO	PAG. 44		TOLOSA	PAG. 23
	ELEGANT	PAG. 36		TRENDY	PAG. 29
	FIORE	PAG. 22		VENEZIA	PAG. 25
	GAYA	PAG. 32		VENUS	PAG. 24
	GIULIA	PAG. 30		VICTORIAN	PAG. 25
	GRANADA	PAG. 33		VIENNETTA	PAG. 39
	KATY	PAG. 27		WIEN	PAG. 38
	LUXOR	PAG. 19		WING	PAG. 43

SECURITY LINE SERIA SECURITY

PAG. 47/49



ZINC LINE SERIA ZINC

	AMBRA ECO	PAG. 53
	AMBRA ECO MINUS	PAG. 56
	BETA ECO	PAG. 54
	CARINA	PAG. 51
	ISCHIA	PAG. 55
	MAREA	PAG. 52
	MARGARET	PAG. 50
	MONICA	PAG. 52
	RIO	PAG. 57
	SOFIA	PAG. 57
	VIENNETTA ECO	PAG. 56

ALLUMINIUM LINE SERIA ALUMINIU

	25164P	PAG. 60
	25139R06	PAG. 60
	ARAD	PAG. 59
	MURES	PAG. 59
	VENERA	PAG. 58

INOX LINE SERIA INOX

	ELLE	PAG. 61
	NOVANTA	PAG. 61
	U	PAG. 61

ACCESSORIES LINE SERIA ACCESORII

PAG. 62/75

CYLINDERS LINE SERIA CILINDRI

PAG. 77/89

EUROPEAN PROFILE CYLINDERS
CILINDRI PROFIL EUROPEAN

SECURITY CYLINDERS WITH REVERSIBLE KEYS
CILINDRI DE SIGURANTA CU CHEI REVERSIBILE

BATHROOM CYLINDERS & THUMBTURN
CILINDRI CU BUTON PENTRU BAIE

CYLINDERS & THUMBTURN - 3 KEYS
CILINDRI CU BUTON & CHEI

SINGLE CYLINDERS & THUMBTURN
SEMICILINDRI CU BUTON

SINGLE CYLINDERS & KEYS
SEMICILINDRI & CHEI

SPECIAL APLICATIONS
APLICATII SPECIALE

LOCKS LINE SERIA BROASTE

035-29	PAG. 91
035-59	PAG. 96
035-91	PAG. 94
035-96	PAG. 95
035-154	PAG. 92
035-171L	PAG. 96
035-174	PAG. 93
035-178	PAG. 97
035-183	PAG. 96
035-199	PAG. 90
035-204	PAG. 97
035-207	PAG. 97
035-210	PAG. 97

SLIDING DOORS LINE

SERIA USI GLISANTE

PAG. 98/100

COMPONENTS COMPONENTE

PAG. 101



MANHATTAN



23082R08 - ZCS

il moderno

nelle **LINEE**

Q-LINE SERIA Q Q-LINE SERIA Q Q-LINE SERIA Q Q-LINE SERIA Q Q-LINE SERIA Q Q-LINE SERIA Q Q-LINE SERIA Q



Design: **Studio.Gea.Italia**



ELISA



23081R08 - ZCS

Handle on rose
Maner cu rozeta

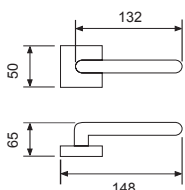

33081DK - ZCS

Tilt and turn handle
DK

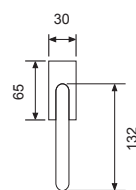



Design: **Studio.Gea.Italia**



DIANA



23080R08 - RAL 9005
 Handle on rose
Maner cu rozeta

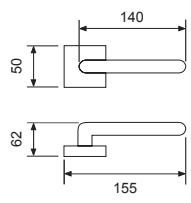

33080DK - RAL 9005
 Tilt and turn handle
 DK

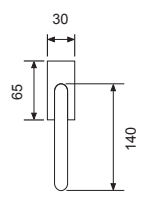



Design: **Studio.Gea.Italia**



MARY



23083R08 - ZCL/ZCS

Handle on rose
Maner cu rozeta

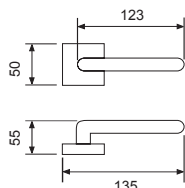

33083DK - ZCL/ZCS

Tilt and turn handle
DK

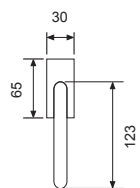



NEW PRAGUE



23070R08 - ZCS
Handle on rose
Maner cu rozeta

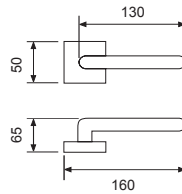

33070DK - ZCS
Tilt and turn handle
DK

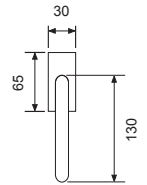

GIUSSY



23063R08 - ZCL/ZCS
Handle on rose
Maner cu rozeta

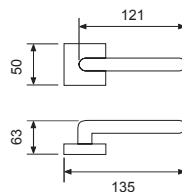

33063DK - ZCS
Tilt and turn handle
DK

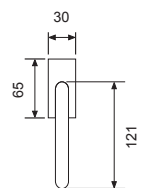



 **CLIO**



23061R08 - ZCL/ZCS

Handle on rose
Maner cu rozeta

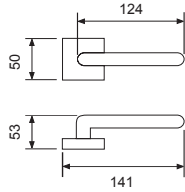

33061DK - ZCS

Tilt and turn handle
DK

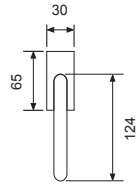

 **VITTORIA**



23013R08 - ZCS

Handle on rose
Maner cu rozeta

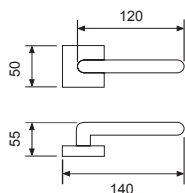

23013DK - ZCS

Tilt and turn handle
DK

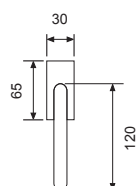

BRASS LINE SERIA ALAMA BRASS LINE SERIA ALAMA BRASS LINE SERIA ALAMA BRASS LINE SERIA ALAMA





LUXOR



OLV



OBG



OBM



21200R09 - OBG

Handle on rose
Maner cu rozeta

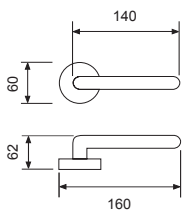

21200P - OBG

Handle on plate
Maner cu placa

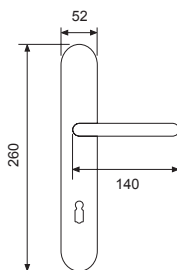

31200DK - OBG

Tilt and turn handle
DK

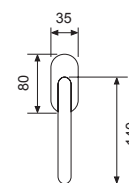

XL MAGNUM SIZE
EXTERNAL DOORS



ALTEA



OLV



OBG



OBM



21070R04 - OBG

Handle on rose
Maner cu rozeta

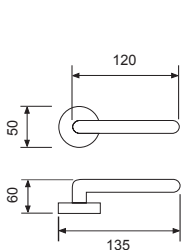

21070P - OBG

Handle on plate
Maner cu placa

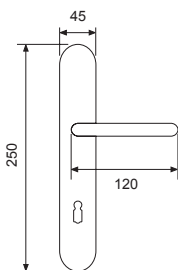

2070 - OBG

Window's plate on handle
Miner cu sild pt fereastra

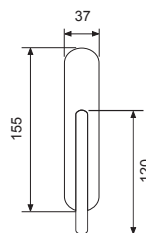

LEFT



RIGHT



31070DK - OBG

Tilt and turn handle
DK

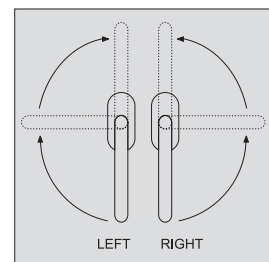
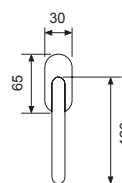

Please specify when is LEFT
Precizati Dreapta sau Stanga





MADEIRA

21094P - OBG

Handle on plate



Maner cu placa

6



OLV



OBG



OBA

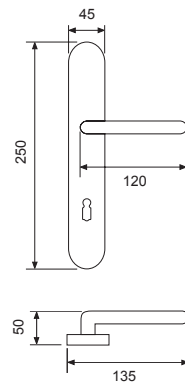

ALICANTE

21079P - OBG

Handle on plate



Maner cu placa

6



OLV



OBG



OBA

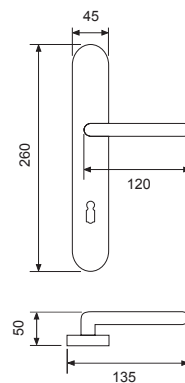



FIORE



OLV



OBG



OBM



21088R03 - OBG

Handle on rose
Maner cu rozeta

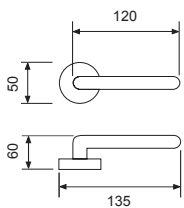

21088P - OBG

Handle on plate
Maner cu placa

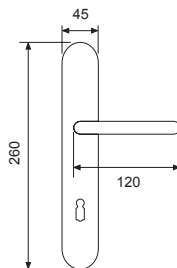

LEFT

RIGHT



31088DK - OBG

Tilt and turn handle
DK

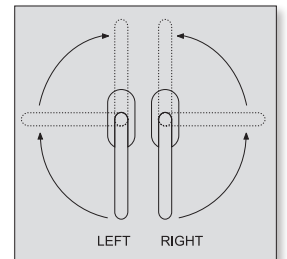
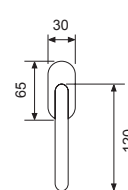

Please specify when is LEFT
Precizati Dreapta sau Stanga





TOLOSA

 OLV/OSV
 OBG
 ONS



21058R03 - OBG
 Handle on rose
Maner cu rozeta

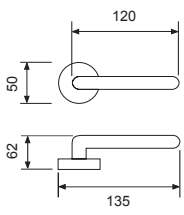

21058P - OBG
 Handle on plate
Maner cu placa

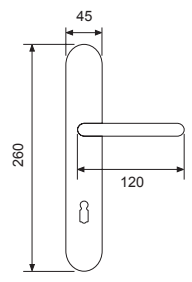

2058 - OBG
 Window handle
Cremon

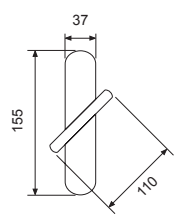

LEFT

RIGHT



31058DK - OBG
 Tilt and turn handle
DK

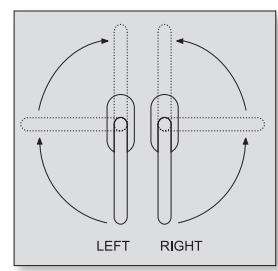
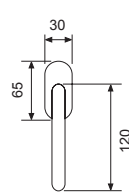

Please specify when is LEFT
Precizati Dreapta sau Stanga



VENUS



OLV



OBG



21034R04 - OGR

Handle on rose
Maner cu rozeta

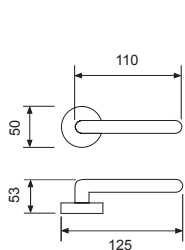

21034P - OBG

Handle on plate
Maner cu placa

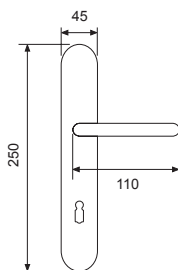

2034 - OBG

Window's plate on handle
Miner cu sild pt fereastra

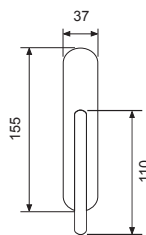

LEFT



RIGHT



31034DK - OBG

Tilt and turn handle
DK

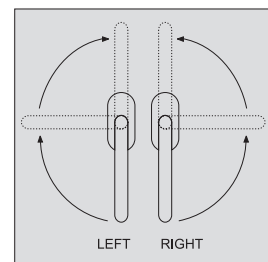
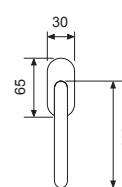

Please specify when is LEFT
Precizati Dreapta sau Stanga





VENEZIA



OLV



OBG



OCL



OCS



ONS



21999R03 - OCS

Handle on rose
Maner cu rozeta

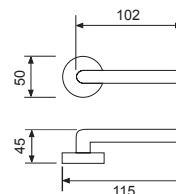

VICTORIAN



OLV



OBG



OCL



OCS



21808R03 - OLV

Handle on rose
Maner cu rozeta

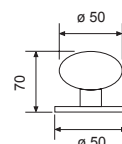



MAURA



21064R03 - OLV

Handle on rose
Maner cu rozeta

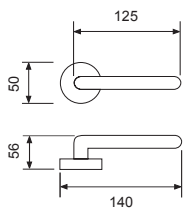

21064P - OLV

Handle on plate
Maner cu placa

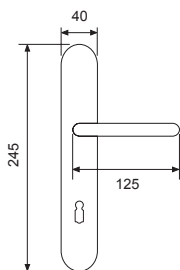

LEFT

RIGHT



31064DK - OLV

Tilt and turn handle
DK

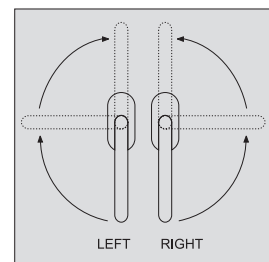
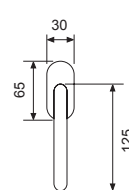

Please specify when is LEFT
Precizati Dreapta sau Stanga





21077R04 - OLV

Handle on rose
Maner cu rozeta

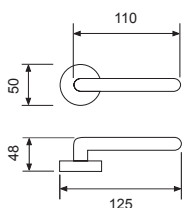

21077P - OLV

Handle on plate
Maner cu placa

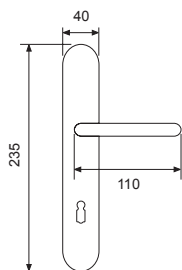

2077 - OLV

Window's plate on handle
Miner cu sild pt fereastr

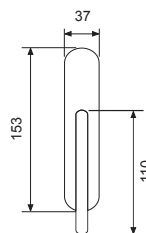

31077DK - OLV

Tilt and turn handle
DK

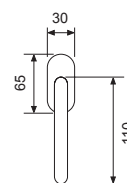



ONDA



OLV



OBG



OCL



OCS



ONS



OLV/OSV



OCL/OCS



21072R04 - OCL/OCS

Handle on rose
Maner cu rozeta

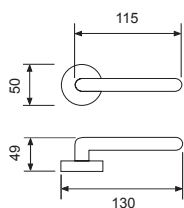

21072P - OCL/OCS

Handle on plate
Maner cu placa

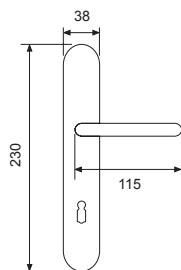

LEFT

RIGHT



31072DK - OCL/OCS

Tilt and turn handle
DK

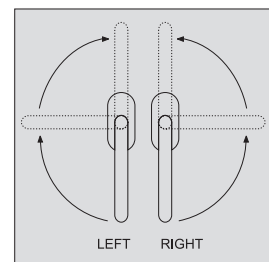
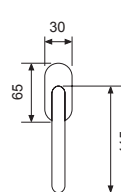

Please specify when is LEFT
Precizati Dreapta sau Stanga





 **TRENDY**

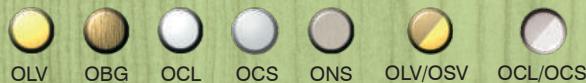

21075R03 - OCL/OCS

Handle on rose
Maner cu rozeta

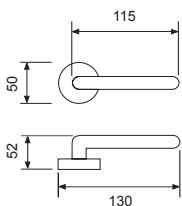

21075P - OCL/OCS

Handle on plate
Maner cu placa

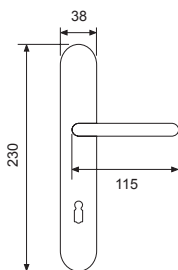

31075DK - OCL/OCS

Tilt and turn handle
DK

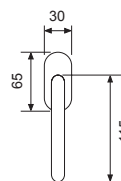



GIULIA



OLV



OBG



OCL



OCS



ONS



21069R04 - OCS

Handle on rose
Maner cu rozeta

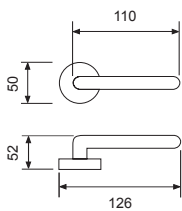

21069P - OCS

Handle on plate
Maner cu placa

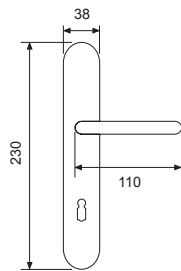

LEFT

RIGHT



31069DK - OCS

Tilt and turn handle
DK

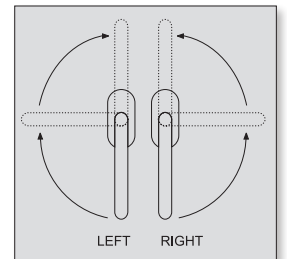
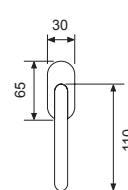

Please specify when is LEFT
Precizati Dreapta sau Stanga





NINFEA



OLV



OBG



OCL



OCS



ONS



21089R04 - OCS

Handle on rose
Maner cu rozeta

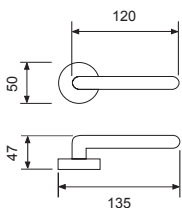

21089P - OCS

Handle on plate
Maner cu placa

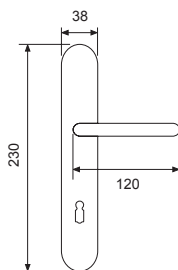

LEFT



RIGHT



31089DK - OCS

Tilt and turn handle
DK

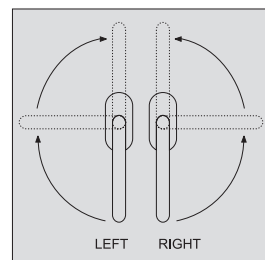
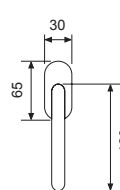

Please specify when is LEFT
Precizati Dreapta sau Stanga





GAYA



21022R03 - OLV

Handle on rose
Maner cu rozeta

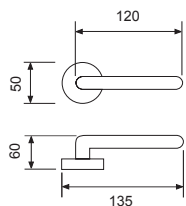

21022P - OLV

Handle on plate
Maner cu placa

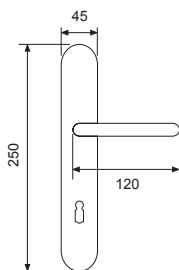

2022 - OLV

Window's plate on handle
Miner cu sild pt fereastr

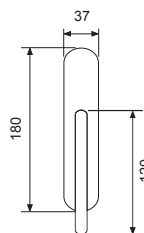

31022DK - OLV

Tilt and turn handle
DK

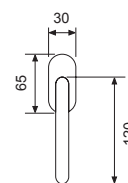



GRANADA



OLV



OBG



OCL



OCS



ONS



21018R03 - OLV

Handle on rose
Maner cu rozeta

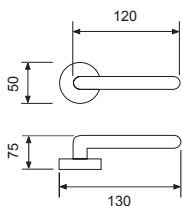

21018P - OLV

Handle on plate
Maner cu placa

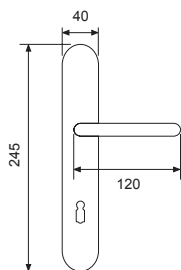

LEFT



RIGHT



31018DK - OLV

Tilt and turn handle
DK

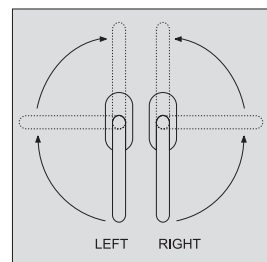
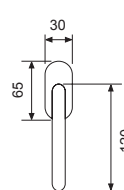

Please specify when is LEFT
Precizati Dreapta sau Stanga





AMBRA



OLV



OBG



OCL



OCS



ONS



21020R03 - OLV

Handle on rose
Maner cu rozeta

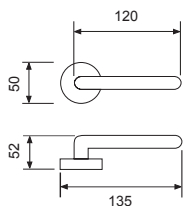

21020P - OLV

Handle on plate
Maner cu placa

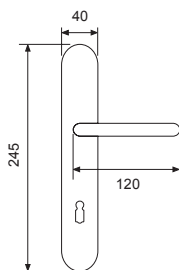

2020 - OLV

Window handle
Cremon

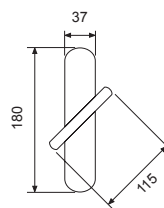

31020DK - OLV

Tilt and turn handle
DK

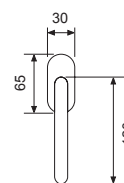



ATENA



OLV



OBG



OCL



OCS



ONS



21016R03 - OCS

Handle on rose
Maner cu rozeta

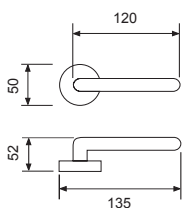

21016P - OCS

Handle on plate
Maner cu placa

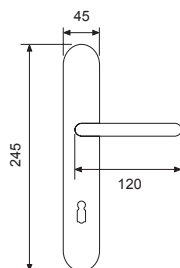

31016DK - OCS

Tilt and turn handle
DK

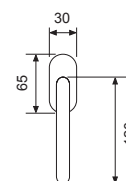



ELEGANT



21078R04 - OLV

Handle on rose
Maner cu rozeta

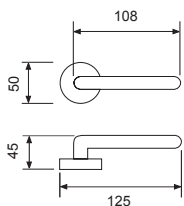

21078P - OLV

Handle on plate
Maner cu placa

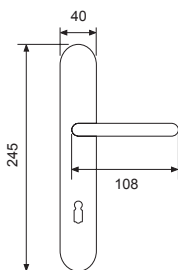

2078 - OLV

Window handle
Cremon

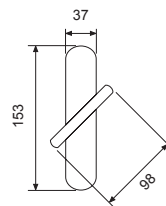

31078DK - OLV

Tilt and turn handle
DK

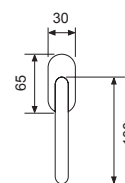



ALT WIEN



OLV



OBG



OBA



OCL



OCS



ONS



21192R04 - OLV

Handle on rose
Maner cu rozeta

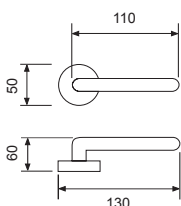

21192P - OLV

Handle on plate
Maner cu placa

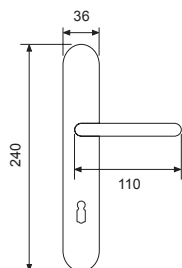

2092 - OLV

Window's plate on handle
Miner cu sild pt fereastră

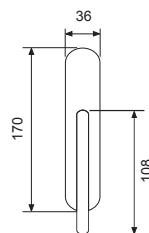

31192DK - OLV

Tilt and turn handle
DK

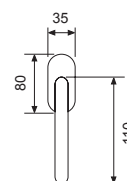



WIEN



OLV



OBG



OBA



OCL



OCS



ONS



21292R04 - OLV

Handle on rose
Maner cu rozeta

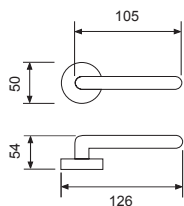

21292P - OLV

Handle on plate
Maner cu placa

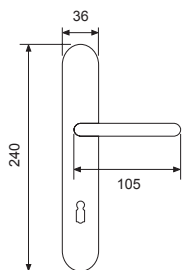

20292 - OLV

Window handle
Cremon

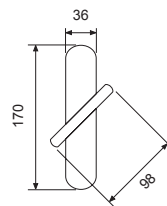

31292DK - OLV

Tilt and turn handle
DK

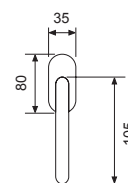



VIENNETA



OLV



OBG



OCL



OCS



ONS



21026R04 - OLV

Handle on rose
Maner cu rozeta

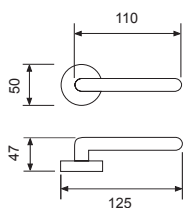

21026P - OLV

Handle on plate
Maner cu placa

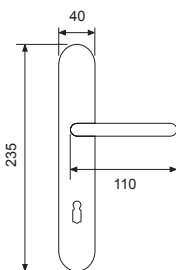

LEFT



RIGHT



31026DK - OLV

Tilt and turn handle
DK

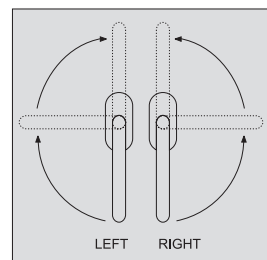
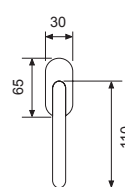

Please specify when is LEFT
Precizati Dreapta sau Stanga



CLAUDIA



21052R04 - ONS

Handle on rose
Maner cu rozeta

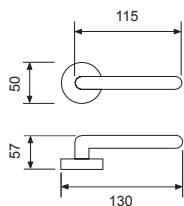

21052P - ONS

Handle on plate
Maner cu placa

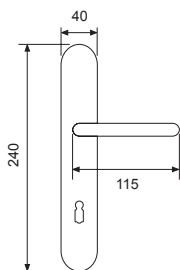

LEFT

RIGHT



31052DK - ONS

Tilt and turn handle
DK

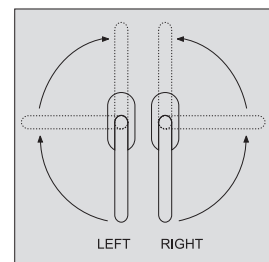
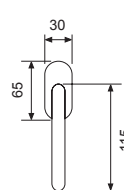

Please specify when is LEFT
Precizati Dreapta sau Stanga





21024R04 - OLV

Handle on rose
Maner cu rozeta

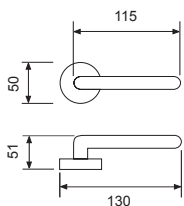

21024P - OLV

Handle on plate
Maner cu placa

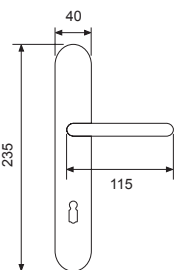

2024 - OLV

Window's plate on handle
Miner cu sild pt fereastr

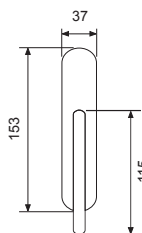

31024DK - OLV

Tilt and turn handle
DK

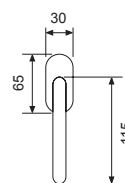



PANDA



OLV



OBG



OCL



OCS



ONS



21057R04 - OLV

Handle on rose
Maner cu rozeta

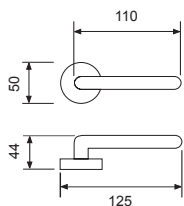

21057P - OLV

Handle on plate
Maner cu placa

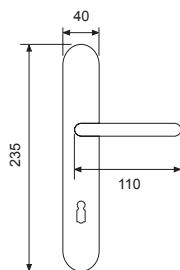

31057DK - OLV

Tilt and turn handle
DK

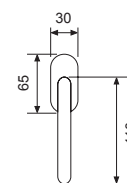



 **WING**



21023R04 - OLV

Handle on rose
Maner cu rozeta

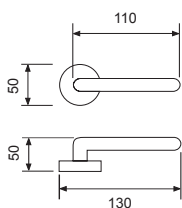

21023P - OLV

Handle on plate
Maner cu placa

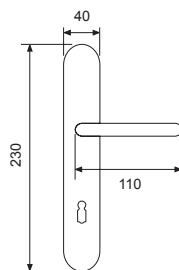

LEFT RIGHT



31023DK - OLV

Tilt and turn handle
DK

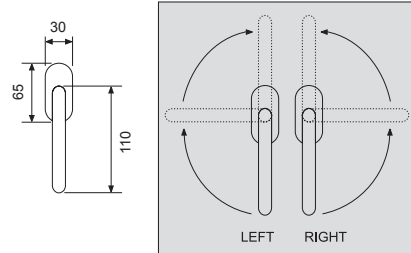

Please specify when is LEFT
Precizati Dreapta sau Stanga



COSMO



OLV



OBG



OCL



OCS



ONS



21080R04 - OBG

Handle on rose
Maner cu rozeta

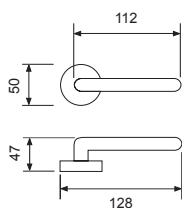

21080P - OBG

Handle on plate
Maner cu placa

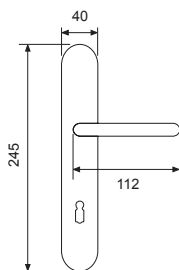

31080DK - OBG

Tilt and turn handle
DK

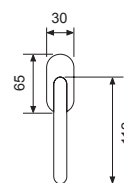



SIMONA



OLV



OBG



OBV



21046R04 - OBV

Handle on rose
Maner cu rozeta

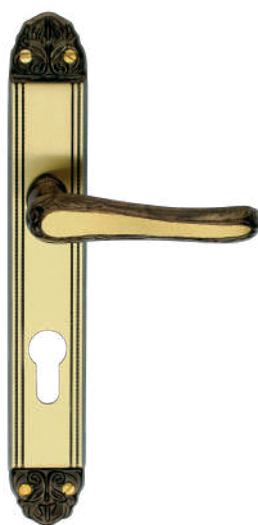
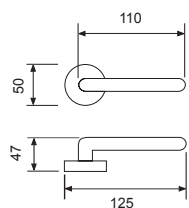

21046P - OBV

Handle on plate
Maner cu placa

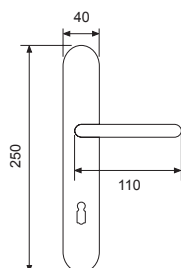

2046 - OBV

Window handle
Cremon

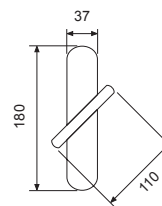

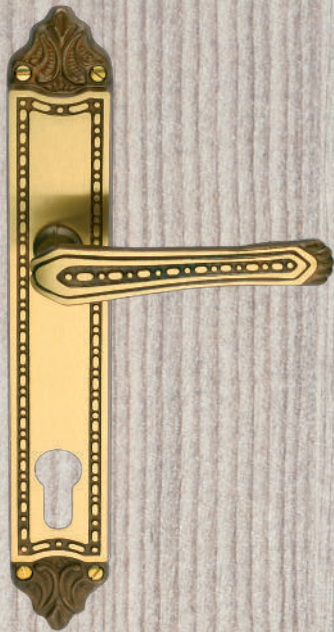

LYUBA

21048P - OBV

Handle on plate



Maner cu placa

12



OBV

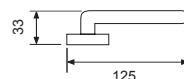
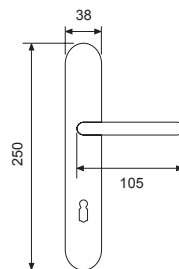

PAPERINO

21044P - OBV

Handle on plate



Maner cu placa

12



OLV



OBV



OBM

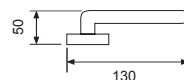
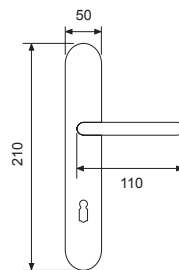

COMBI

21047P - OBV

Handle on plate



Maner cu placa

12



OLV



OBV



OBM

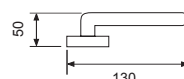
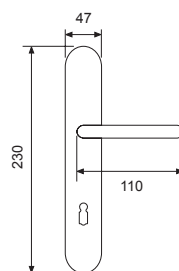



safety

systems

***for armored
doors***



LAURA

21015B/1 - OLV

Set for armoured doors:
 ***21015B/1 CONSISTING IN:

- . BRASS HANDLE
- . BRASS KNOB
- . INTERNAL PROTECTION PLATE HARDENED AND NON / DRILLABLE
- . 2 ANCHORING SCREWS NOT ACCESSIBLE FROM THE OUTSIDE. THE IRON SQUARCAN BE 8*90 OR NIPLEX

Set for armoured doors:
 ***21015B/1 COMUPUS DIN:

- . MINER DIN ALAMA
- . BUTON DIN ALAMA
- . PLACA DE PROTECTIE CALITA SI NEPERFORABILA
- . 2 SURUBURI MONTAJ NEACCESIBILE DIN EXTERIOR / TIJA METALICE POT FI DE 8*90 SAU NIPLEX



21015P/1 - OCS

Set for armoured doors:
 ***21015P/1 CONSISTING IN:

- . BRASS HANDLES
- . BRASS PLATES
- . CYLINDER PROTECTION SELF/ADAPTING
- . INTERNAL PROTECTION PLATE HARDENED AND NON / DRILLABLE
- . 2 ANCHORING SCREWS NOT ACCESSIBLE FROM THE OUTSIDE

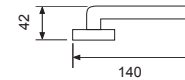
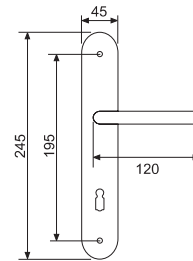

Set for armoured doors:
 ***21015P/1 COMUPUS DIN:

- . MANERE DIN ALAMA
- . SILD DE ALAMA
- . PASTILA DE PROTECTIE CILINDRU CU AUTOADAPTAREA
- . PLACA DE PROTECTIE CALITA SI NEPERFORABILA
- . 2 SURUBURI MONTAJ NEACCESIBILE DIN EXTERIOR



BERLINO



23020R04/B

***23020R04/B CONSISTING IN:

HANDLE WITH ROSE R04
DOOR KNOB BERLINO ART. 3381R04
CAN BE FIXED WITH THREADED SCREW
OR NIPLEX

***23020R04/B COMUPUS DIN:

MINER PE ROZETA R04
CU BUTON TIP BERLINO ART. 3381R04
POT FI FIXATE CU SURUB FILETAT SAU
NIPLEX

Other accessories:

Nyplex 10 MA
8x90 mm- 8x100 mm

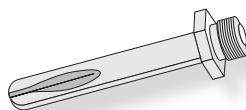

BLINDO

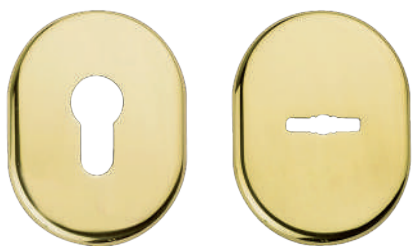

B50Y

62X82 mm

B50DM

62X82 mm

DEFENDER



B52Y

ø 52 mm - h 12 mm



TECHNICAL DRAWING TO FIX / INSTRUCIUNI TEHNICE PENTRU FIXARE

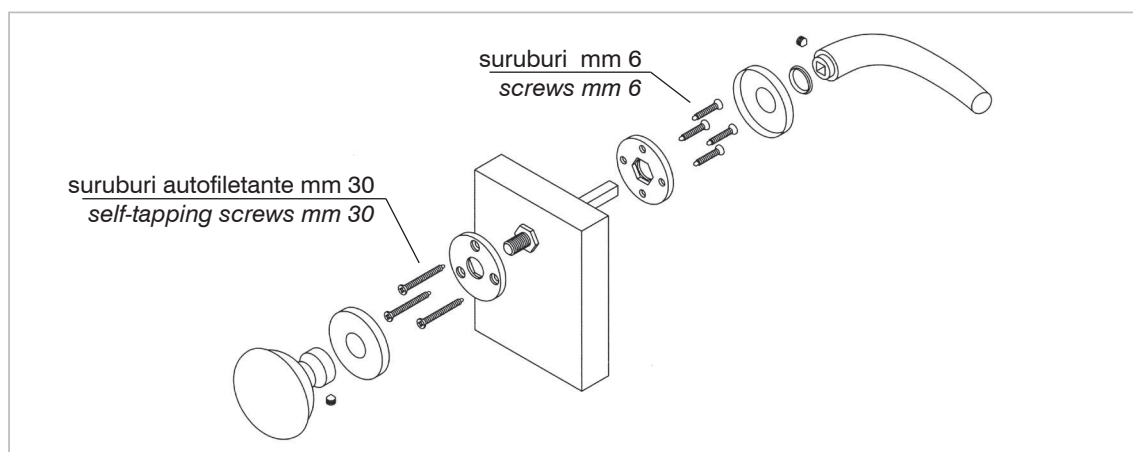



23040R03 - ZCL/ZCS



23040R04 - ZCS



23040R04 - ZCL



CARINA



ZOLV



ZBG



ZCL



ZCS



ZNS



23066R04 - ZCS

Handle on rose
Maner cu rozeta

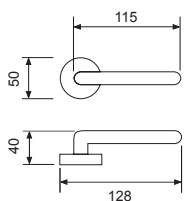

23066PF - ZCS

Handle on plate
Maner cu placa

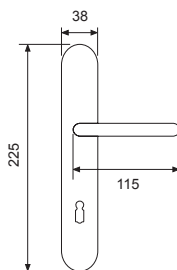

33066DK - ZCS

Tilt and turn handle
DK

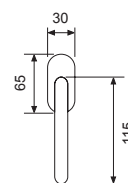



MAREA



ZOLV



ZBG



ZCL



ZCS



ZNS



23062R04 - ZCS

Handle on rose
Maner cu rozeta

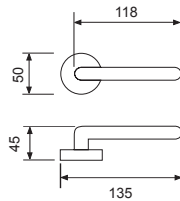

33062DK - ZCS

Tilt and turn handle
DK

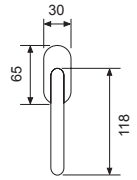

MONICA



ZOLV



ZBG



ZCL



ZCS



ZNS



23050R04 - ZCS

Handle on rose
Maner cu rozeta

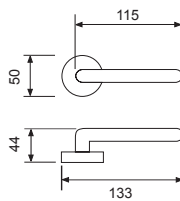

33050DK - ZCS

Tilt and turn handle
DK

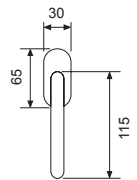



AMBRA ECO



ZOLV



ZBG



ZCL



ZCS



ZNS



23079R04 - ZC

Handle with rpl
Maner cu rozeta rpl

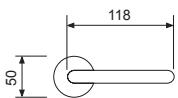

23079PF - ZCS

Handle with plate
Maner cu placa

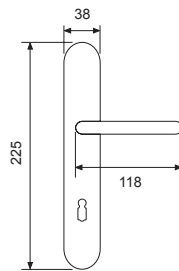

33079DK - ZC

Tilt and turn handle
DK

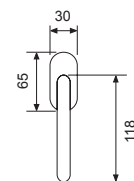



BETA ECO



ZOLV



ZBG



ZCL



ZCS



ZNS



23024R04 - ZCL

Handle on rose
Maner cu rozeta

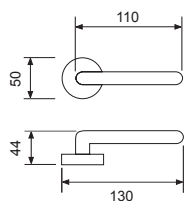

23024PF - ZCS

Handle on plate
Maner cu placa

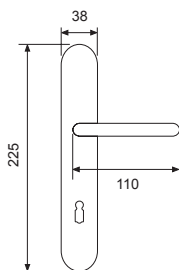

33024DK - ZCL

Tilt and turn handle
DK

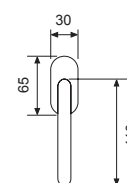



ISCHIA



ZOLV



ZBG



ZCL



ZCS



ZNS



23072R04 - ZCS

Handle on rose
Maner cu rozeta

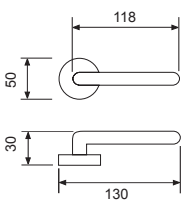

23072PF - ZCS

Handle on plate
Maner cu placa

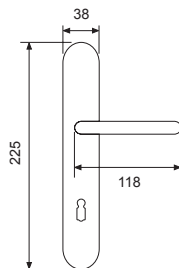

33072DK - ZCS

Tilt and turn handle
DK

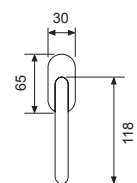



AMBRA ECO MINUS



23079MR04 - ZCL

Handle on rose
Maner cu rozeta

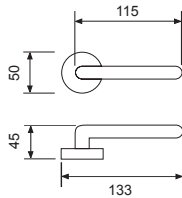

23079MR06 - ZCL

Handle on rose
Maner cu rozeta

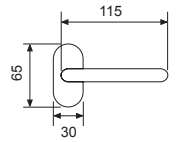

VIENNETTA ECO



23026R04 - ZCL

Handle on rose
Maner cu rozeta

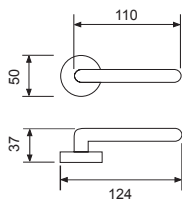

33026DK - ZCL

Tilt and turn handle
DK

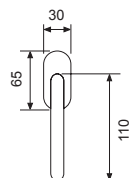



SOFIA

ZCL/ZNS



22001R23 - ZCL/ZNS
Handle on rose
Maner cu rozeta

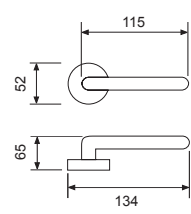

RIO

ZCL/ZNS



22002R23 - ZCL/ZNS
Handle on rose
Maner cu rozeta

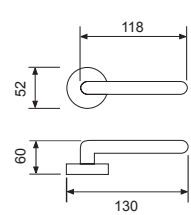



VENERA



F1



F4



F5



F6



22063R04 - F4

Handle on rose
Maner cu rozeta

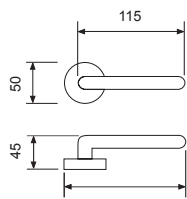

22063P - F4

Handle on plate
Maner cu placa

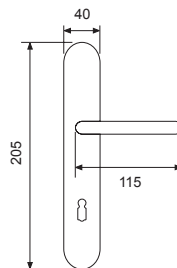

32063DK - F4

Tilt and turn handle
DK

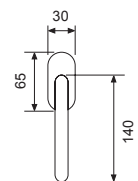



MURES



F5



F6



25115R04 - F6

Handle on rose
Maner cu rozeta

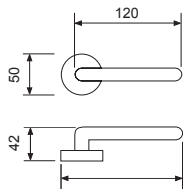

25115P - F6

Handle on plate
Maner cu placa

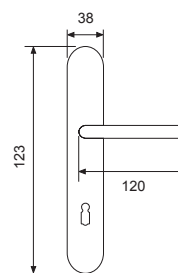

ARAD



F5



F6



25150R04 - F6

Handle on rose
Maner cu rozeta

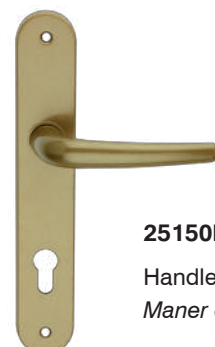
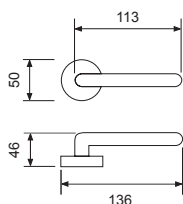

25150P - F6

Handle on plate
Maner cu placa

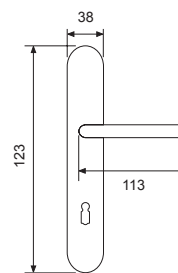



25164P

25164P - RAL 9016

Handle on plate



Maner cu placa

25



RAL 9016



RAL 8022



F5



F6

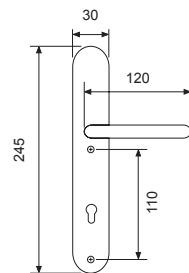

25139R06

25139R06 - RAL 9016

Handle on rose



Maner cu rozeta

25



RAL 9016



RAL 9005

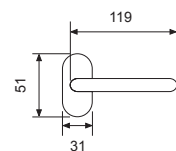



ELLE



24070R05 - INOX SAT

Handle on rose
Maner cu rozeta

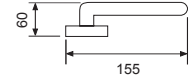
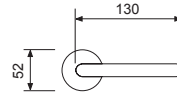

NOVANTA



24071R05 - INOX SAT

Handle on rose
Maner cu rozeta

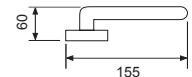
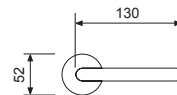

U



1072R05 - INOX SAT

Handle on rose
Maner cu rozeta

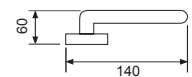
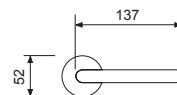

BRASS PULL-HANDLES MANERE TRAGATOARE DIN ALAMA



MANHATTAN

23082T - OCS

Pull-handle	
Manere tragatoare	1

	A	B
23082T	200	230
33082T	300	330
48082T	450	480

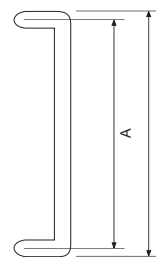

ELISA

31581T - OCS

Pull-handle	
Manere tragatoare	1

	A	B
31581T	200	230
31582T	230	260

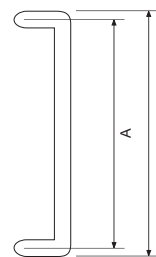

BRASS PULL-HANDLES
 MANERE TRAGATOARE DIN ALAMA



 **LUCIA**

31507T - OCL/OCS

Pull-handle



Manere tragatoare

1



OLV/OSV



OCL/OCS

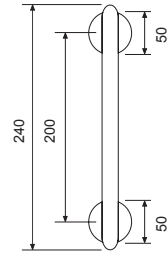

 **GARDA**

31510T - OCL/OCS

Pull-handle



Manere tragatoare

1



OLV/OSV



OCL/OCS

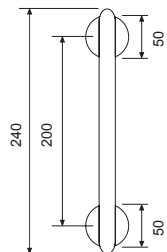

BRASS PULL-HANDLES
 MANERE TRAGATOARE DIN ALAMA



315200T - OLV

Pull-handle

Manere tragatoare



1



OLV



OBG



OBA

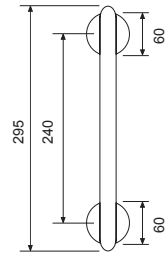



 **GRANADA**

31518T - OLV

Pull-handle

Manere tragatoare



1



OLV



OBG

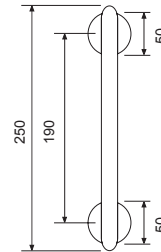

 **MADRID**

31532T - OLV

Pull-handle

Manere tragatoare



1



OLV



OBG

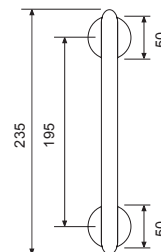

STAINLESS STEEL PULL-HANDLES
 MANERE TRAGATOARE DIN OTEL INOXIDABIL

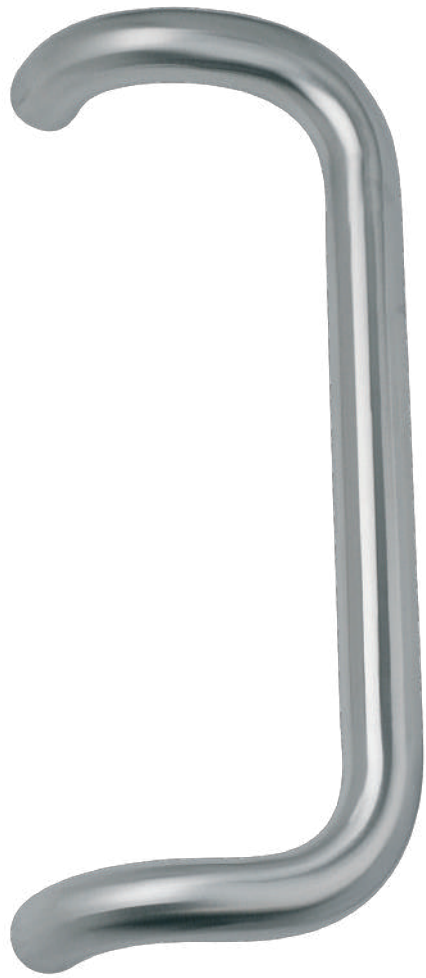

DELTA



GAMMA

34502T - INOX SAT

Pull-handle



Manere tragatoare

1



INOX SAT

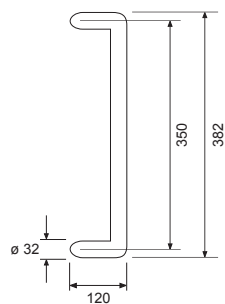

34503T - INOX SAT

Pull-handle



Manere tragatoare

1



INOX SAT

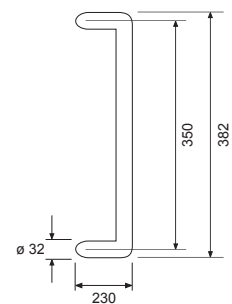

STAINLESS STEEL PULL-HANDLES MANERE TRAGATOARE DIN OTEL INOXIDABIL

ACCESSORIES LINE SERIA AC- ACCESSORII SERIA ACCESORII

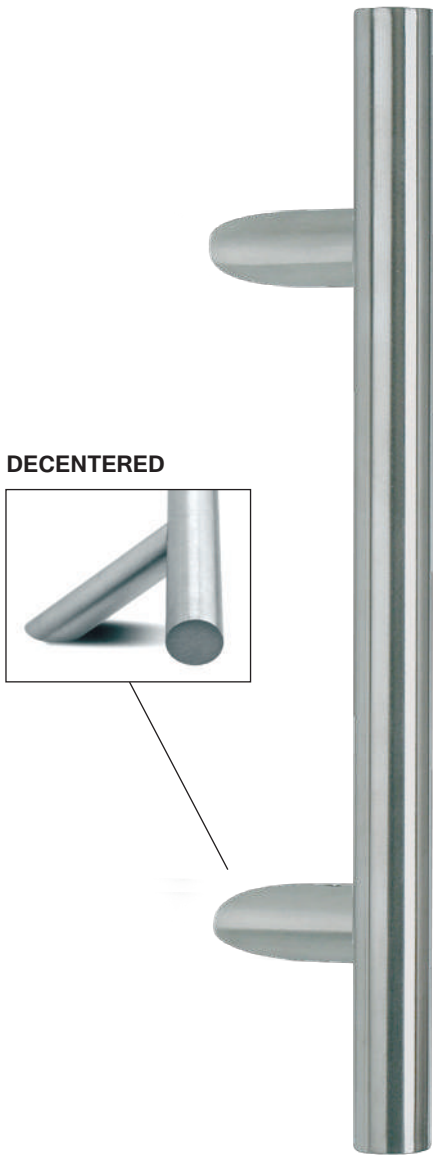

THEMA

34506T - INOX SAT

Pull-handle 
Manere tragatoare | 1

	A	B	C	H
34506T	300	460	45	80
36506T	500	660	45	80
36116T	1000	1160	45	80

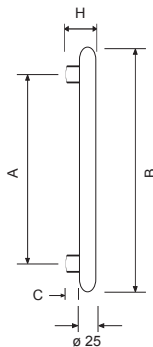

ELLE

34505T - INOX SAT

Pull-handle 
Manere tragatoare | 1

INOX SAT

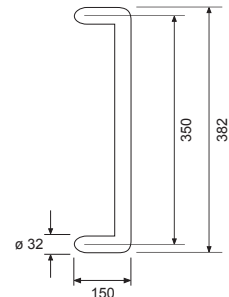



INOX SAT

BRASS FIXED KNOBS
BOTOANE FIX DIN ALAMA



 **BERLINO**

33811R80 - ZOLV

Fixed door-knob	
<i>Butoane fix</i>	6

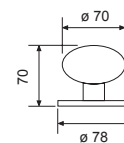

-  ZOLV
-  ZBG
-  ZCS
-  ZCL

33811R07 - ZOLV

Fixed door-knob	
<i>Butoane fix</i>	6

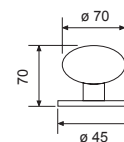

-  ZOLV
-  ZBG
-  ZCS
-  ZCL



 **VICTORIAN**

31808R03 - OLV

Fixed door-knob	
<i>Butoane fix</i>	6

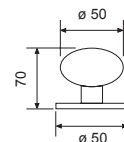

-  OLV
-  OBG
-  OCS
-  OCL

ZAMAC FIXED KNOBS
BOTOANE FIX DIN ZAMAC



PARIGI

33812R08 - ZCS

Fixed door-knob

Butoane fix



6

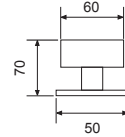

ZCL



ZCS



PARIGI DEC

33812R08/1 - ZCS

Fixed door-knob

Butoane fix



6

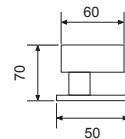

ZCL



ZCS

WINDOW'S ACCESSORIES ACCESORII PENTRU FERESTRE

KLEIN



33813R04 - ZOL

Knob on rose for opening limiting device



30

Buton limitare deschidere usa

ø 50 mm



ZOL ZCS

OLIVA



33815R04 - ZOL

Knob on rose for opening limiting device



30

Buton limitare deschidere usa

ø 50 mm



ZOL ZCS

FRANCESE



33812R12 - ZCS

Knob on rose for opening limiting device



30

Buton limitare deschidere usa

30x65 mm



ZCS

NAPOLEONE



33814R12 - ZCS

Knob on rose for opening limiting device



30

Buton limitare deschidere usa

30x65 mm



ZCS

ELEGANT

▶ page 36

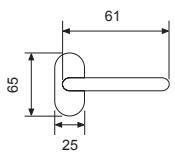

31078OL - OLV

Half handle on oliver rose



30

Oliver

AMBRA

▶ page 34

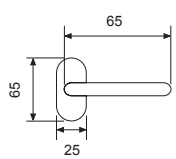

31020OL - OLV

Half handle on oliver rose



30

Oliver

GRANADA

▶ page 33

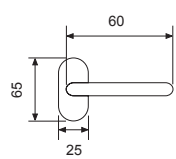

31022OL - OLV

Half handle on oliver rose



30

Oliver

WIEN

▶ page 38

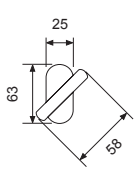

31192S - OLV

Window handle on oliver rose



30

Oliver T

WIEN

▶ page 38

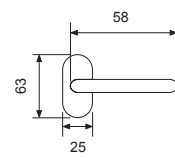

31192OL - OLV

Half handle on oliver rose



30

Oliver



OLV OBG OCL OCS ONS

WINDOW'S ACCESSORIES ACCESORII PENTRU FERESTRE

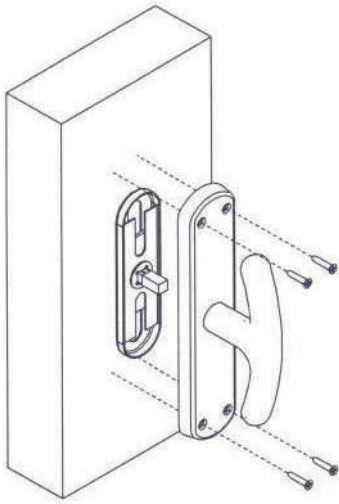

153x37 mm



170x36 mm



180x37 mm



153x37 mm

ELEGANT

▶ page 36

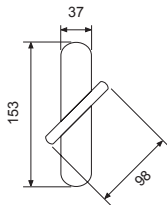

2078 - OLV

Window handle



Cremon

12

TOLOSA

▶ page 23

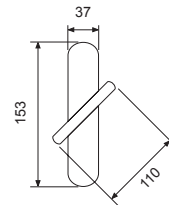

2058 - OGR

Window handle



Cremon

12



WIEN

▶ page 38

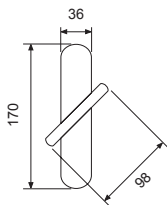

2092 - OLV

Window handle



Cremon

12

AMBRA

▶ page 34

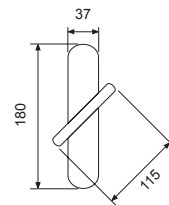

2020 - OLV

Window handle



Cremon

12

SIMONA

▶ page 45

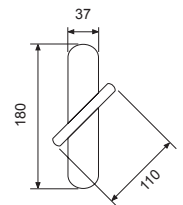

2046 - OBV

Window handle



Cremon

12

DIFFERENT COMPLEMENTS
 DIFERITE COMPONENTE



 **LEU**

31703 - OLV

Knocker

Batatoare



25

180x120 mm



OLV



OBG

31704 - OLV

Knocker

Batatoare



25

120x90 mm



OLV



OBG



4001 - OLV

Cover roller

Role de acoperire



25

240x55 mm



OLV



OBG



OCS



OCL



4002 - OLV

Cover roller

Role de acoperire



25

260x58 mm



OLV



OBG



OCS



OCL

DIFFERENT COMPLEMENTS DIFERITE COMPONENTE



31600L/2 - OLV

Small brass letters <i>Litere mici din alama</i>	
	25

50x38 mm



31600N/1 - OLV

Big brass numerals <i>Numere mari din alama</i>	
	25

125x73 mm



31600N/2 - OLV

Small brass numerals <i>Numere mici din alama</i>	
	25

75x40 mm



31601 - OLV

Doors stop <i>Opritoare usi</i>	
	150

ø 45 mm













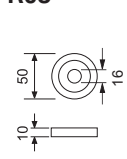

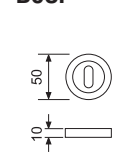

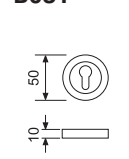

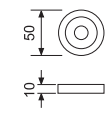

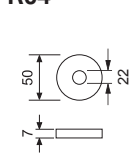

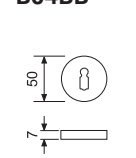

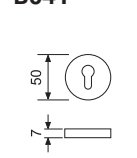

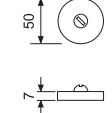

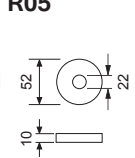

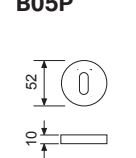

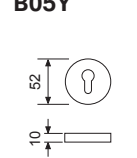

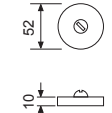
31602 - OLV

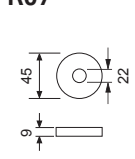
Doors stop <i>Opritoare usi</i>	
	150

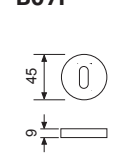
35x27 mm

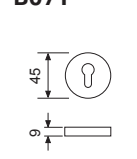

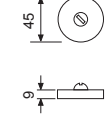
ROSES - TOILET ROSES - ESCUTCHEONS
 ROZETA - ROZETA WC - BOCHETTA

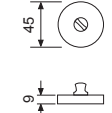
	R03 		B03P 		B03Y 		R03WC 
	R04 		B04BB 		B04Y 		R04WC 
	R05 		B05P 		B05Y 		R05WC 
	R07 		B07P 		B07Y 		R07WC 
							

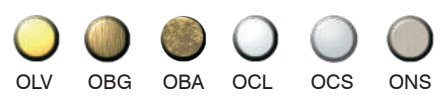

ROSES - TOILET ROSES - ESCUTCHIONS ROZETA - ROZETA WC - BOCHETTA

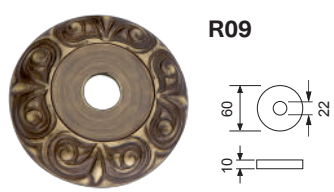

R09

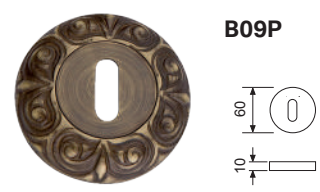

B09P



B09Y

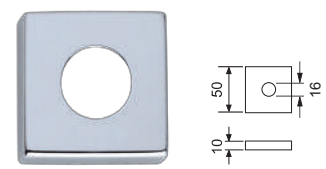

R08 F/Z

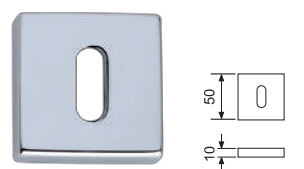

B08P F/Z

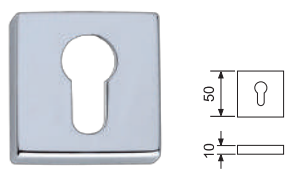

B08Y F/Z

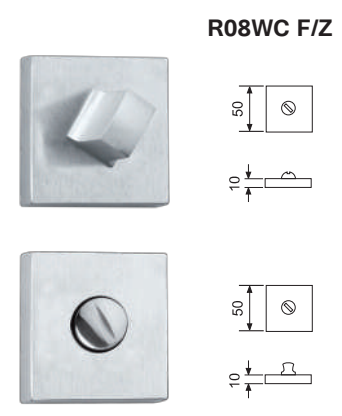

R08WC F/Z

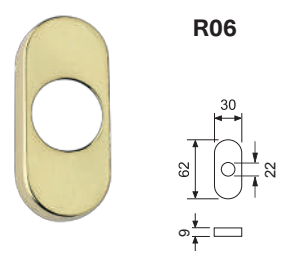

R06

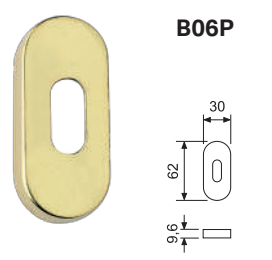

B06P

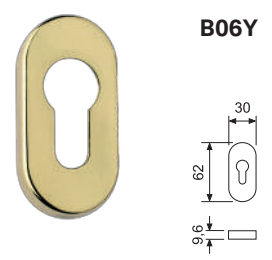

B06Y

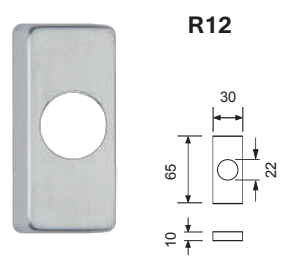

R12

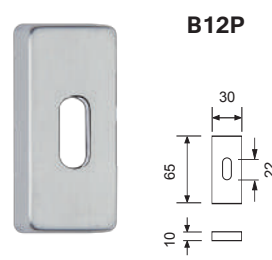

B12P

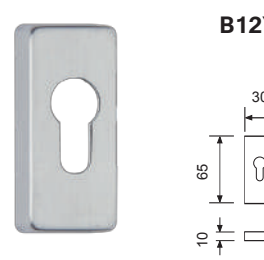

B12Y

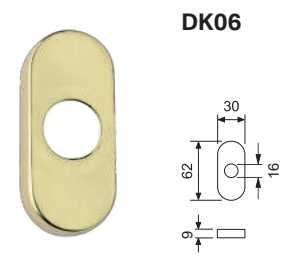

DK06

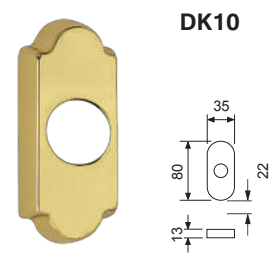

DK10

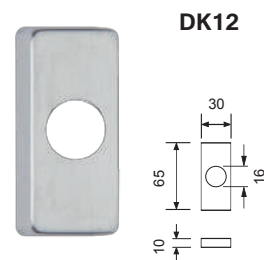

DK12

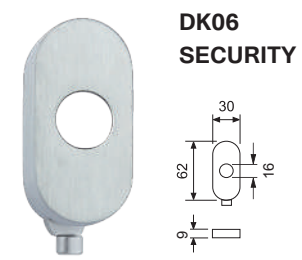

DK06 SECURITY

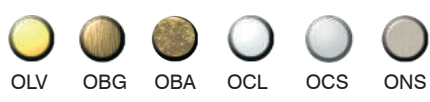



VERO FER

BINALIA



Verofer®



BINALIA®

A businessman is both a pioneer and an inventor, he acts with brave, he is able to lose with dignity, but he is able to restart with enthusiasm.

Un om de afaceri este deopotrivă un pionier și un inventator, acționează cu curaj, este capabil să piardă cu demnitate, dar este întotdeauna în stare să reînceapă cu entuziasm.

GIROLAMO VERCELLINI
Founder Verofer srl



Verofer[®]

Cylinders and
Complements



Registration Certificate

This is to certify that the Management Systems of

SC VEROFER SRL

have been assessed by AJA Europe Ltd and registered against the requirements of

ISO 9001:2008

Certificate No. : AJAEU/12/12739 Date of Original Registration : 12/06/2012

Expiry Date : 10/05/2018 Date of Re-Registration : 18/05/2015



Alfonso Pagliuca

Alfonso Pagliuca, Chief Executive, AJA Europe Ltd



This certificate is issued in respect of the locations & scope of registration detailed in the Associated Registration Schedule. This certificate is the property of AJA Europe Ltd Unit 6 Gordano Court Gordano Gate Business Park Serbert Close Porritshard Bristol UK BS20 7FS and must be returned on request. A member of the AJA Group of Companies

Registration Schedule

SCOPE OF REGISTRATION

Productie si comercializare produse din fieronerie (din alama), inclusiv activitati aferente de proiectare. Manufacture and sale of ironmongery (from brass), including related design activities.

Company Name: **SC VEROFER SRL**

Sites Registered: Str. 6 Vanatori, nr 51-53
Localitate Arad
Judet Arad
Romania

Standard: **ISO 9001:2008**

EAC: 17

Date of Re-Registration: 18/05/2015

Expiry Date: 10/05/2018

Certificate Number: AJAEU/12/12739



Alfonso Pagliuca

Alfonso Pagliuca, Chief Executive, AJA Europe Ltd



This certificate is the property of AJA Europe Ltd Unit 6 Gordano Court Gordano Gate Business Park Serbert Close Porritshard Bristol UK BS20 7FS and must be returned on request. A member of the AJA Group of Companies

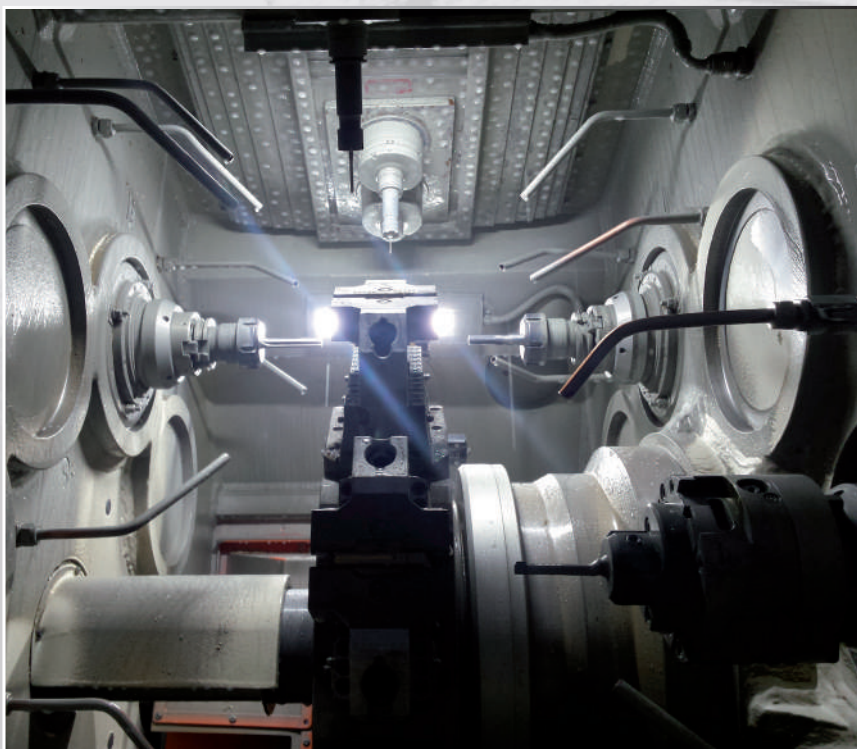

Verofer®

Cylinders and Complements

IMP INSTITUTE OF PRECISION MECHANICS
 CERTIFICATION DEPARTMENT
 01-796 Warszawa, ul. Duchnicka 3
 phone 22 663-43-24, 22 560-28-00 e-mail: marek.zietala@imp.edu.pl
 http://www.imp.edu.pl/cert

PCA
 POLSKI CENTRUM
 AKREDYTACJI
 CERTYFIKACJA
 WYTRZYMAŁOŚCI
 AC 041

CERTIFICATE OF CONFORMITY

No. P41/374/2016 (6955)
 ENGLISH EDITION

Name and address of the certificate owner:
VEROFER SRL
 Calea 6 Vanatori nr 51/53, 310162 Romania

Name and address of the manufacturer:
VEROFER SRL
 Calea 6 Vanatori nr 51/53, 310162 Romania

Product name:
Profile cylinder

Type (variants):
 Cilindru de siguranta din alama
 Cilindru de siguranta din alama nichelat
 Cilindru de siguranta din alama buton/chei
 Cilindru de siguranta din alama buton/chei nichelat
 Semicilindru de siguranta din alama
 Semicilindru de siguranta din alama nichelat

Main features: Class of protection: - 4 - acc. to PN-EN 1303:2015-07

Class of protection:

Category of use	No of test cycles/ durability	Door mass	Fire resistance	Safety in use	Corrosion resistance	Protection requirements	Attack resistance
1	6	0	0	0	C	4	0

The product fulfills requirements of:
PN-EN 1303:2015-07

Date of expiration and certificate validity conditions: **October 11, 2019**

This certificate is valid from **October 12, 2016** until **October 11, 2019** only for products covered by application No. 158/W/2016, provided that the technical specification is valid, item fulfills its requirements and there were no major changes in: product type, system, conditions and the place of the production.

Certification of conformity Type . 3* acc. to PN-EN ISO/IEC 17067: 2014-01.
 Certificate of conformity issued acc. to the program PC-03 (IMP)

MANAGER
 CERTIFICATION DEPARTMENT

 Marek ZIETALA M.Sc. Eng.

DIRECTOR
 INSTITUTE OF PRECISION MECHANICS

 Tomasz BABUL Ph.D. D.Sc. Eng. prof. IMP



Certificate can be published only by Certificate Owner without comments, abbreviations and changes.
 Warsaw, October 12, 2016.

INSTITUTE OF PRECISION MECHANICS
 Form No. F-2.2.1, edition 5, May 20, 2016

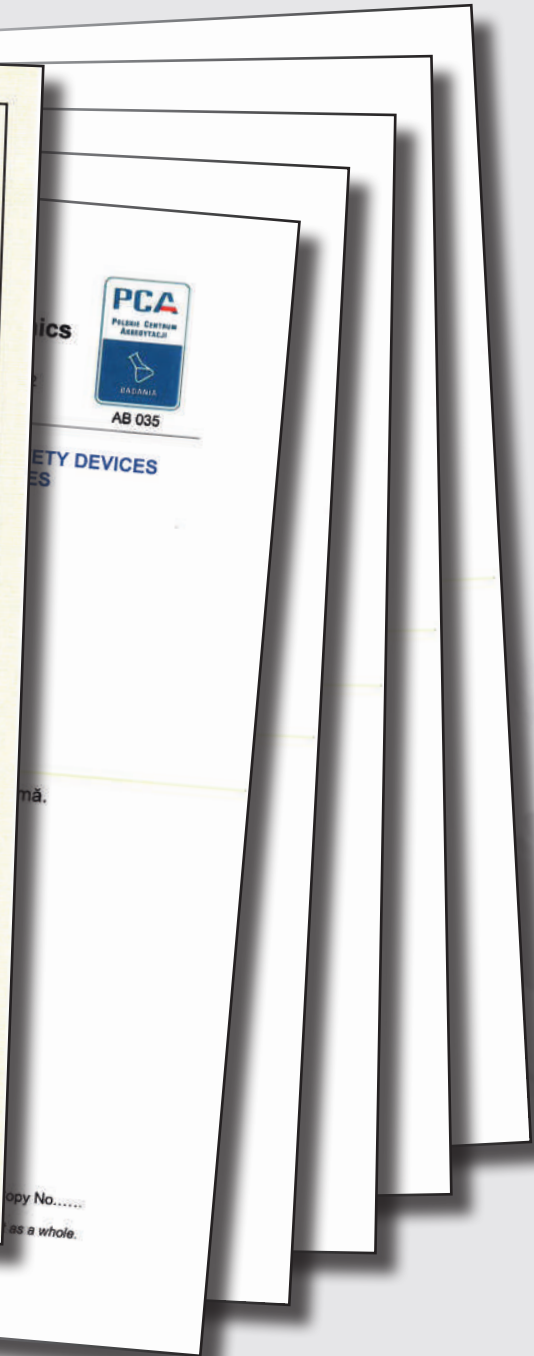

All our brass cylinders are produced
 under the UNI EN 1303 : 2015 - 07 norm

*Cilindri Verofer sunt realizati din alama respectand
 standardul UNI EN 1303 : 2015 - 07 norm*



EUROPEAN PROFILE CYLINDERS CILINDRI PROFIL EUROPEAN

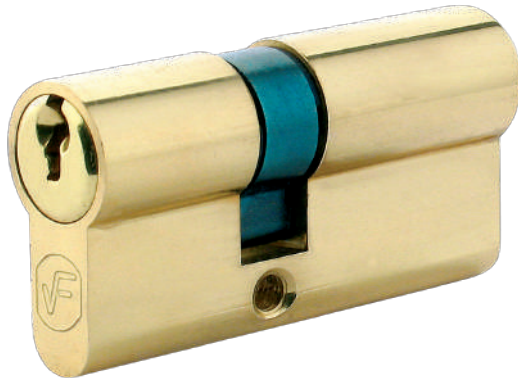

Cylinders are in brass supplied with:
 . 3 brass nickel keys
 . cam UNI or DIN
 . fixing screw M 5x60

Cilindri sunt dotati cu:
 . 3 chei din alama nichelate
 . paleta UNI sau DIN
 . surub M 5x60

Paleta UNI

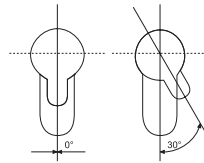

Paleta DIN

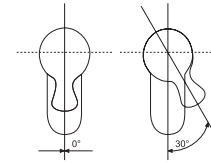

CODE <i>COD</i>	A	B mm.	L	PINS <i>Nr. Stifturi</i>	1 PCS EACH BOX <i>Buc/cutie</i>	50 PCS EACH CARTON <i>Buc/bax</i>
110540	27	27	54	8	1	50
110581	27	31	58	8	1	50
110600	30	30	60	10	1	50
110601	25	35	60	8	1	50
110651	30	35	65	10	1	50
110700	35	35	70	10	1	50
110701	30	40	70	10	1	50
110751	35	40	75	10	1	50
110752	30	45	75	10	1	50
110800	40	40	80	10	1	50
110801	30	50	80	10	1	50
110802	35	45	80	10	1	50
110851	35	50	85	10	1	50
110852	40	45	85	10	1	50
110900	45	45	90	10	1	50
110901	35	55	90	10	1	50
110902	40	50	90	10	1	50
110903	30	60	90	10	1	50
110951	40	55	95	10	1	50
110952	45	50	95	10	1	50
110953	30	65	95	10	1	50
110954	35	60	95	10	1	50
111000	50	50	100	10	1	50
111001	45	55	100	10	1	50
111002	35	65	100	10	1	50
111051	45	60	105	10	1	50
111052	50	55	105	10	1	50
111101	45	65	110	10	1	50
111102	50	60	110	10	1	50
111151	50	65	115	10	1	50

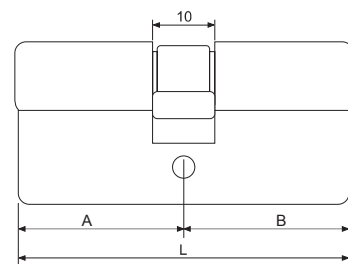
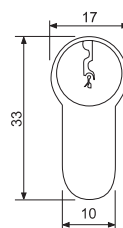

BRASS-01 NIKEL-02

CYLINDERS LINE SERIA CILINDRI CYLINDERS LINE SERIA CILINDRI





SECURITY CYLINDERS WITH REVERSIBLE KEYS CILINDRI DE SIGURANTA CU CHEI REVERSIBILE

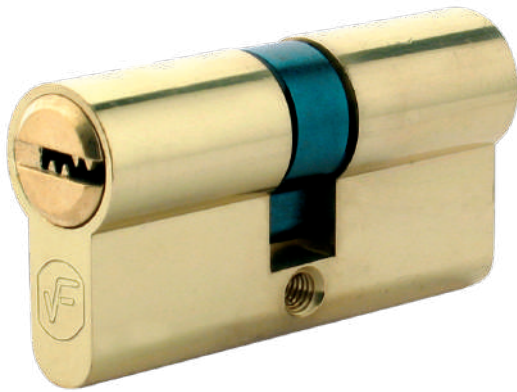

Cylinders are in brass supplied with:
 . 4 brass nichel keys
 . cam UNI or *DIN*
 . fixing screw M 5x60

Cilindri sunt dotati cu:
 . 4 chei din alama nichelate
 . paleta UNI sau DIN
 . surub M 5x60

Paleta UNI

Paleta DIN

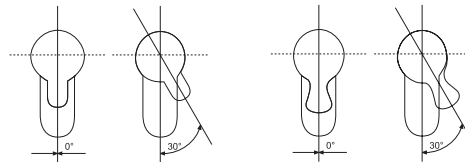

CODE <i>COD</i>	A	B mm.	L	PINS <i>Nr. Stifturi</i>	1 PCS EACH BOX <i>Buc/cutie</i>	50 PCS EACH CARTON <i>Buc/bax</i>
110600A	30	30	60	10	1	50
110651A	30	35	65	10	1	50
110700A	35	35	70	10	1	50
110701A	30	40	70	10	1	50
110751A	35	40	75	10	1	50
110752A	30	45	75	10	1	50
110800A	40	40	80	10	1	50
110801A	30	50	80	10	1	50
110802A	35	45	80	10	1	50
110851A	35	50	85	10	1	50
110852A	40	45	85	10	1	50
110900A	45	45	90	10	1	50
110901A	35	55	90	10	1	50
110902A	40	50	90	10	1	50
110903A	30	60	90	10	1	50
110951A	40	55	95	10	1	50
110952A	45	50	95	10	1	50
111000A	50	50	100	10	1	50
111001A	45	55	100	10	1	50
111051A	45	60	105	10	1	50
111052A	50	55	105	10	1	50
111102A	50	60	110	10	1	50

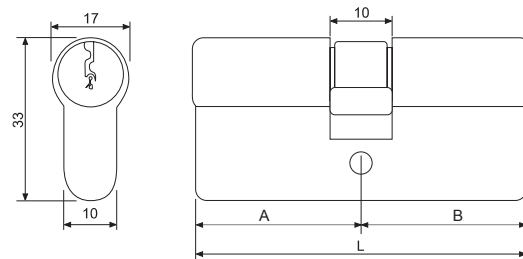

BRASS-01



NIKEL-02



BATHROOM CYLINDERS & THUMBTURN CILINDRI CU BUTON PENTRU BAIE

SERIA CILINDRI

CYLINDERS LINE

SERIA CILINDRI

CYLINDERS LINE



Cylinders are in brass supplied with:
 . cam UNI or DIN
 . fixing screw M 5x60

Cilindri sunt dotati cu:
 . paleta UNI sau DIN
 . surub M 5x60

Paleta UNI

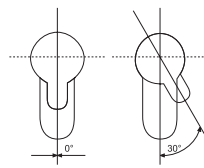

Paleta DIN

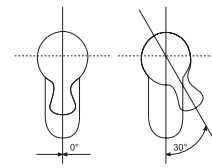

CODE <i>COD</i>	A	B mm.	L	PINS <i>Nr. Stifuri</i>	1 PCS EACH BOX <i>Buc/cutie</i>	50 PCS EACH CARTON <i>Buc/bax</i>
110540W	27	27	54	-	1	50
110581WL	27	31	58	-	1	50
110581WS	31	27	58	-	1	50
110600W	30	30	60	-	1	50
110601WL	25	35	60	-	1	50
110601WS	35	25	60	-	1	50
110651WL	30	35	65	-	1	50
110651WS	35	30	65	-	1	50
110700W	35	35	70	-	1	50
110701WL	30	40	70	-	1	50
110701WS	40	30	70	-	1	50
110751WL	35	40	75	-	1	50
110751WS	40	35	75	-	1	50
110800W	40	40	80	-	1	50
110801WL	30	50	80	-	1	50
110801WS	50	30	80	-	1	50
110802WL	35	45	80	-	1	50
110802WS	45	35	80	-	1	50
110851WL	35	50	85	-	1	50
110851WS	50	35	85	-	1	50
110852WL	40	45	85	-	1	50
110852WS	45	40	85	-	1	50
110900W	45	45	90	-	1	50
110901WL	35	55	90	-	1	50
110901WS	55	35	90	-	1	50
110902WL	40	50	90	-	1	50
110902WS	50	40	90	-	1	50
110951WL	40	55	95	-	1	50
110951WS	55	40	95	-	1	50
110952WL	45	50	95	-	1	50
110952WS	50	45	95	-	1	50

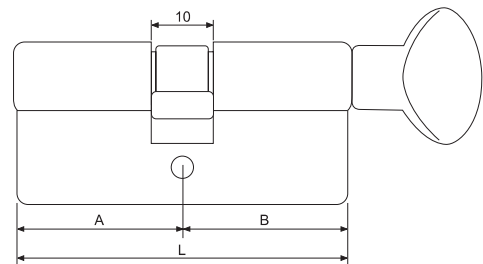
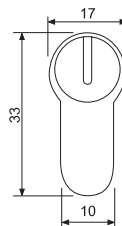

BRASS-01



NIKEL-02





CYLINDERS WITH THUMBTURN & 3 KEYS CILINDRI CU BUTON & CHEI



Cylinders are in brass supplied with:

- . 3 brass nichel keys
- . cam UNI or *DIN*
- . fixing screw M 5x60

Cilindri sunt dotati cu:

- . 3 chei din alama nichelate
- . paleta UNI sau *DIN*
- . surub M 5x60

Paleta UNI

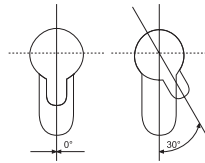

Paleta DIN

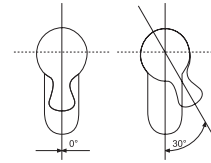

CODE <i>COD</i>	A	B mm.	L	PINS <i>Nr. Stifturi</i>	1 PCS EACH BOX <i>Buc/cutie</i>	50 PCS EACH CARTON <i>Buc/bax</i>
110540B	27	27	54	4	1	50
110581BL	27	31	58	4	1	50
110581BS	31	27	58	4	1	50
110600B	30	30	60	5	1	50
110601BL	25	35	60	5	1	50
110601BS	35	25	60	5	1	50
110651BL	30	35	65	5	1	50
110651BS	35	30	65	5	1	50
110700B	35	35	70	5	1	50
110701BL	30	40	70	5	1	50
110701BS	40	30	70	5	1	50
110751BL	35	40	75	5	1	50
110751BS	40	35	75	5	1	50
110800B	40	40	80	5	1	50
110801BL	30	50	80	5	1	50
110802BL	35	45	80	5	1	50
110802BS	45	35	80	5	1	50
110851BL	35	50	85	5	1	50
110852BL	40	45	85	5	1	50
110852BS	45	40	85	5	1	50
110900B	45	45	90	5	1	50
110901BL	35	55	90	5	1	50
110902BL	40	50	90	5	1	50
110951BL	40	55	95	5	1	50
110952BL	45	50	95	5	1	50

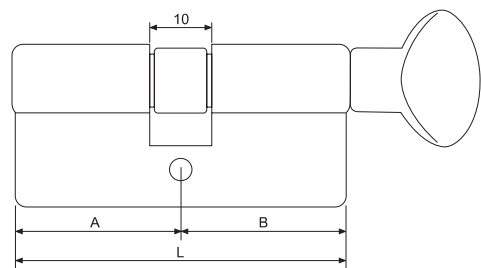
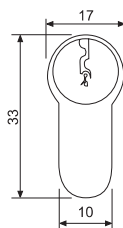

BRASS-01



NIKEL-02



SINGLE CYLINDERS & THUMBTURN SEMICILINDRI CU BUTON

CYLINDERS LINE SERIA CILINDRI



Cylinders are in brass supplied with:
 . cam UNI or *DIN*
 . fixing screw M 5x60

Cilindri sunt dotati cu:
 . paleta UNI sau *DIN*
 . surub M 5x60

Paleta UNI

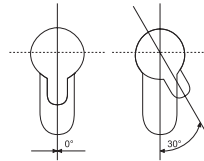

Paleta DIN

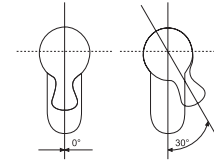

CODE <i>COD</i>	A	B mm.	L	PINS <i>Nr. Stifturi</i>	1 PCS EACH BOX <i>Buc/cutie</i>	100 PCS EACH CARTON <i>Buc/bax</i>
110401BL	10	30	40	-	1	50
110451BL	10	35	45	-	1	50
110501BL	10	40	50	-	1	50

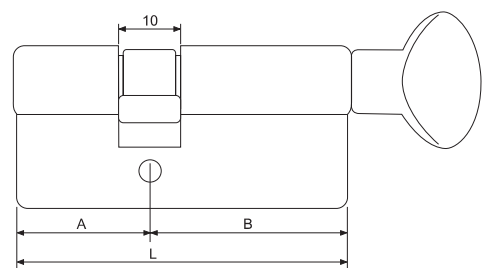
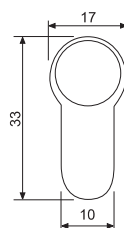

BRASS-01



NIKEL-02





SINGLE CYLINDERS & KEYS

SEMICILINDRI & CHEI



Cylinders are in brass supplied with:

- . 3 brass nichel keys
- . cam UNI or DIN
- . fixing screw M 5x60

Cilindri sunt dotati cu:

- . 3 chei din alama nichelate
- . paleta UNI sau DIN
- . surub M 5x60

Paleta UNI

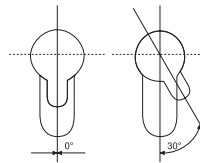

Paleta DIN

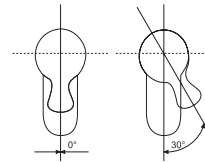

CODE <i>COD</i>	A	B mm.	L	PINS <i>Nr. Stifturi</i>	1 PCS EACH BOX <i>Buc/cutie</i>	100 PCS EACH CARTON <i>Buc/bax</i>
110351	10	25	35	4	1	50
110401	10	30	40	5	1	50
110451	10	35	45	5	1	50
110501	10	40	50	5	1	50

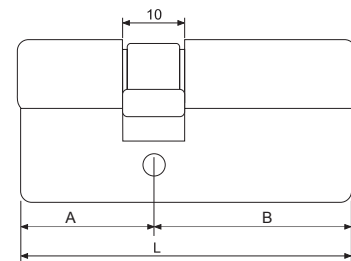
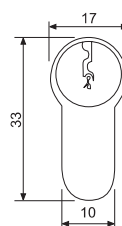

BRASS-01



NIKEL-02



Master key

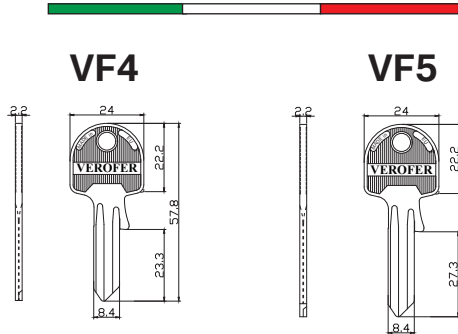
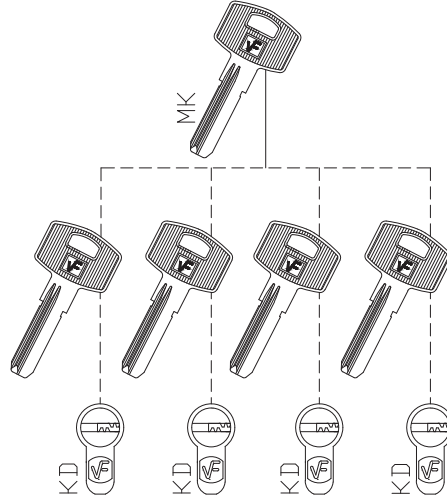

CODE	A	B	L	PINS
<i>COD</i>	mm.			<i>Nr. Stifturi</i>
110600_MK	30	30	60	10
110651_MK	30	35	65	10
110700_MK	35	35	70	10
110701_MK	30	40	70	10
110800_MK	40	40	80	10
110802_MK	35	45	80	10
110852_MK	40	45	85	10
110900_MK	45	45	90	10
110902_MK	40	50	90	10
110951_MK	40	55	95	10
110952_MK	45	50	95	10





Construction/definitive keys Cheie de constructie/definitiva

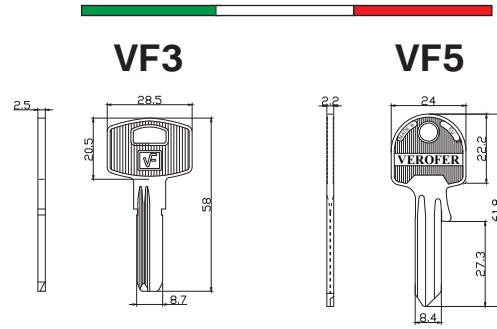
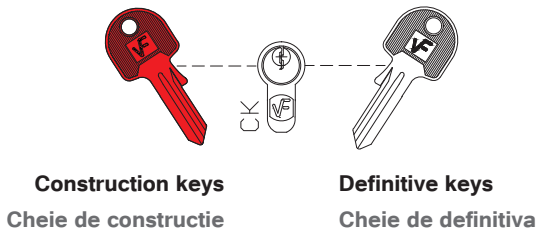

Keys
 Cheie

CODE <i>COD</i>	A	B mm.	L	PINS <i>Nr. Stifturi</i>
110600_CC	30	30	60	10
110651_CC	30	35	65	10
110700_CC	35	35	70	10
110701_CC	30	40	70	10
110800_CC	40	40	80	10
110802_CC	35	45	80	10
110852_CC	40	45	85	10
110900_CC	45	45	90	10
110902_CC	40	50	90	10
110951_CC	40	55	95	10
110952_CC	45	50	95	10

Thumbturn
 Buton

CODE <i>COD</i>	A	B mm.	L	PINS <i>Nr. Stifturi</i>
110600B_CC	30	30	60	5
110651BL_CC	30	35	65	5
110700B_CC	35	35	70	5
110701BL_CC	30	40	70	5
110800B_CC	40	40	80	5
110802BL_CC	35	45	80	5
110852BL_CC	40	45	85	5
110852BS_CC	45	40	85	5
110900B_CC	45	45	90	5
110902BL_CC	40	50	90	5
110951BL_CC	40	55	95	5
110952BL_CC	45	50	95	5



Emergency function Cilindru cu functia de urgenta

Cylinders are in brass supplied with:
 . brass nichel keys
 . cam UNI or DIN
 . fixing screw M 5x60

Cilindri sunt dotati cu:
 . chei din alama nichelate
 . paleta UNI sau DIN
 . surub M 5x60

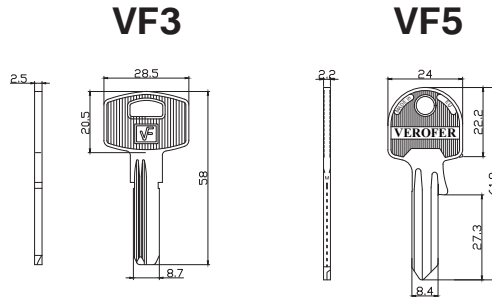
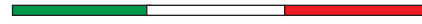
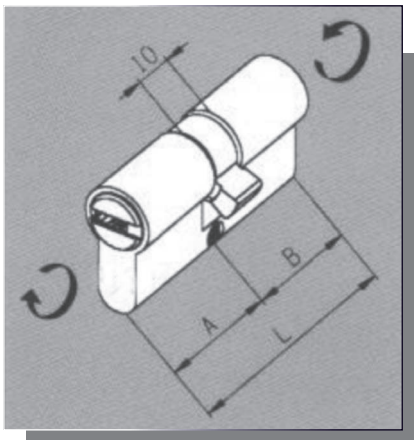

CODE <i>COD</i>	A	B mm.	L	PINS <i>Nr. Stifturi</i>
110600_DF	30	30	60	10
110651_DF	30	35	65	10
110700_DF	35	35	70	10
110701_DF	30	40	70	10
110800_DF	40	40	80	10
110802_DF	35	45	80	10
110852_DF	40	45	85	10
110900_DF	45	45	90	10
110902_DF	40	50	90	10
110951_DF	40	55	95	10
110952_DF	45	50	95	10

Cylinder for thumbturn Cilindru pt buton

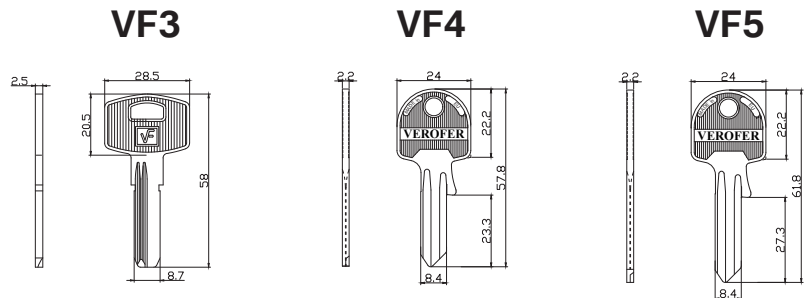
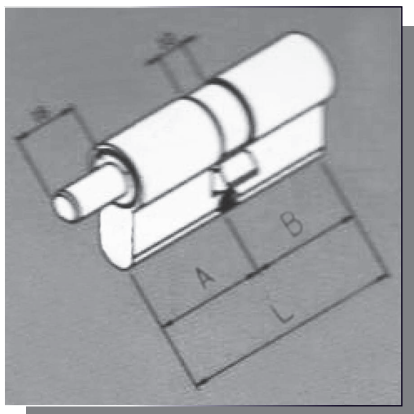

Paleta UNI

Paleta DIN

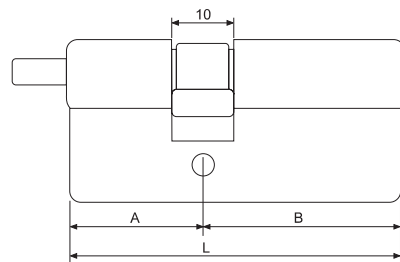
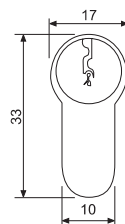
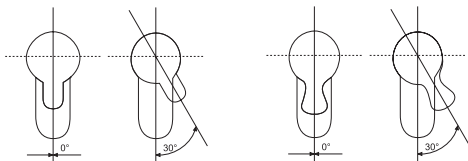



Individual keys
Cheie individuale

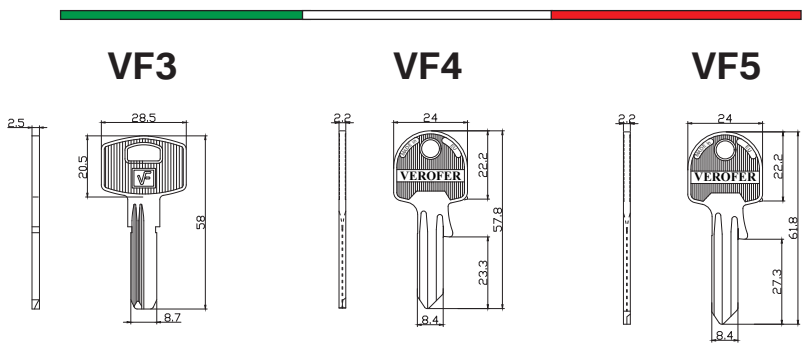
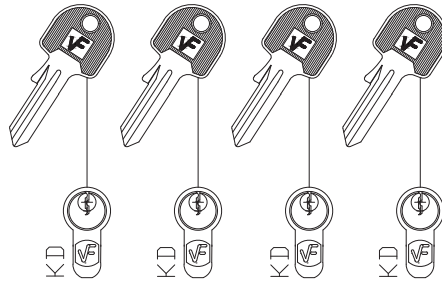

Same keys
Aceeasi cheie

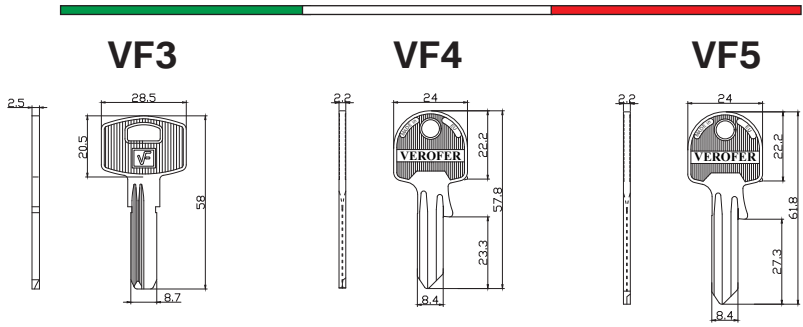
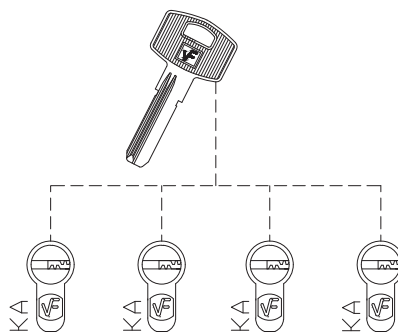



LOCKS FOR WOODEN DOORS
BROASTE PENTRU USI DIN LEMN



035-199

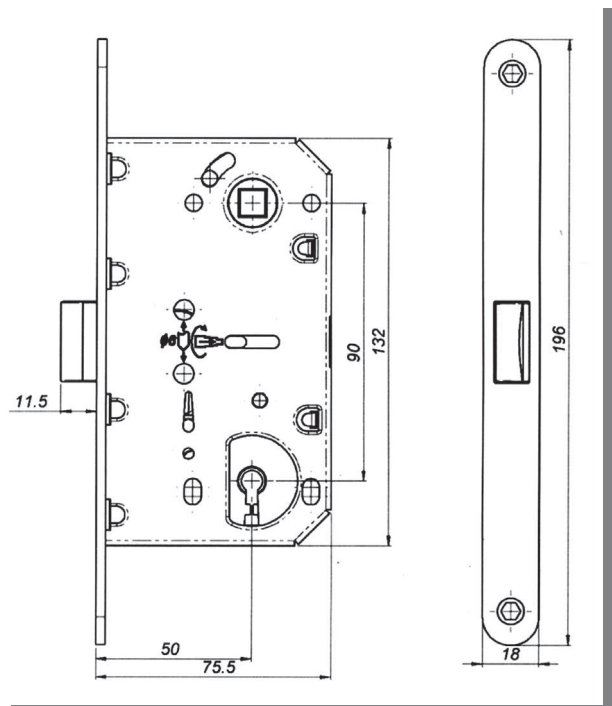

Cod. produs	Tip	Characteristics	L	A	Finishing	Packing	Striking Plate
035-199	P		90	A50	OL	50	035-204
035-200	Y	DIN	85		CS		035-207
035-201	WC	Q 6	96		BG		035-210

The door lock is reversible. The door latch could be retreated also by using the key.
Broasca este reversibila. Limba broastei se poate retrage si din cheie.





LOCKS FOR WOODEN DOORS
BROASTE PENTRU USI DIN LEMN



035-154

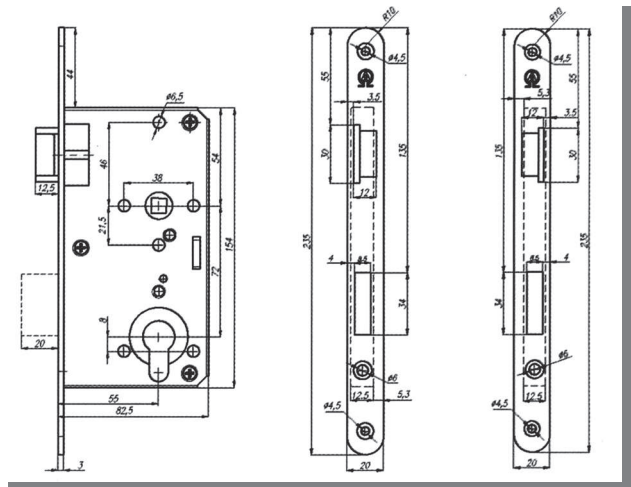

Cod. produs	Tip	Characteristics	L	A	Finishing	Packing	Striking Plate
035-154	P left		72	A55	ZI ZA S PAINTED+ NATUR	20/01	035-183
035-155	P right						
035-186	P						
035-150	Y left	 DIN					
035-151	Y right						
035-187	Y						
035-152	WC left	Q.6,8	72				
035-153	WC right		78				
035-188	WC		78				

The door lock is not reversible. In case of Y type the door latch could be retreated also by using the key.
Broasca nu este reversibila. La varianta Y limba broastei se poate retrage si din cheie.







LOCKS FOR WOODEN DOORS BROASTE PENTRU USI DIN LEMN

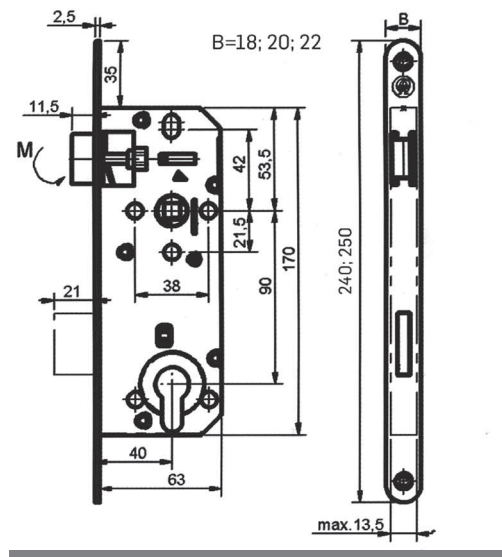

035-174



Cod. produs	Tip	Characteristics	L	A	Finishing	Packing	Striking Plate
035-174	P		90	A40	ZI		
035-181				A50			
035-175	Y	 DIN	85	A40	ZA	20/01	035-178
035-182				A50			
035-177				A40			
035-180	WC	Q.6,8	90	A40	PAINTED+ NATUR		
035-184				A50			

The door lock is reversible. In case of 035-182 type the door latch could be retreated also by using the key.
Broasca este reversibila. La varianta 035-182 limba broastei se poate retrage si din cheie.



LOCKS FOR ALLUMINIUM DOORS
BROASTE PENTRU USI DIN ALUMINIU



035-91

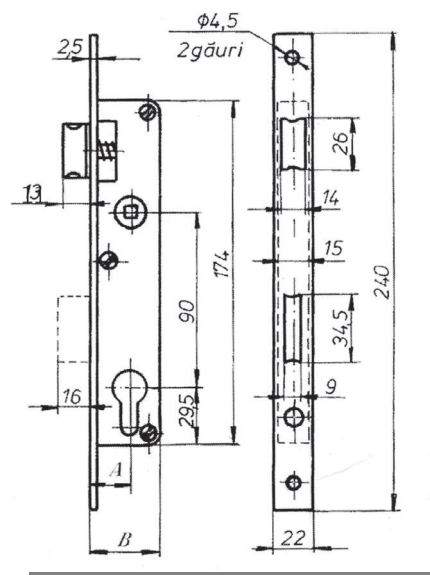

Cod. produs	Tip	Characteristics	L	A	Finishing	Packing	Striking Plate
035-92	Y	 DIN	92	A35	NIK+ZA	20/1	035-122
035-91			85	A35			
035-108			92	A30			
035-106			85	A30			
035-115			92	A25			
035-113			85	A25			

The door lock is reversible. The door latch could be retreated also by using the key.
Broasca este reversibila. Limba broastei se poate retrage si din cheie.







LOCKS FOR PVC DOORS BROASTE PENTRU USI DIN PVC

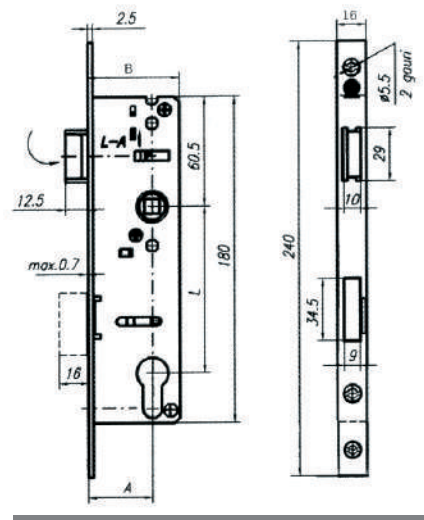

035-96



Cod. produs	Tip	Characteristics	L	A	Finishing	Packing	Striking Plate
035-96	Y	 DIN	92	A35	NIK+ZA	20/1	035-171L 035-172 R
035-95			85	A35			
035-111			92	A30			
035-109			85	A30			
035-123			92	A25			
035-118			85	A25			
035-158			85	A20			

The door lock is reversible. The door latch could be retreated also by using the key.
Broasca este reversibila. Limba broastei se poate retrage si din cheie.



STRIKING PLATES CONTRA PLACI



035-59 - OP

Striking plates
Contra placi



50

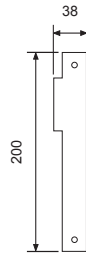

035-183 - ZA

Striking plates
Contra placi



50



035-171L - ZA

Striking plates
Contra placi



50

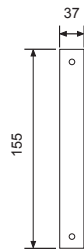



STRIKING PLATES CONTRO PLACI



035-204 - CRS

035-210 - CRS

Striking plates

Striking plates

Contro placi

Contro placi

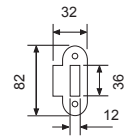
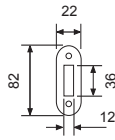
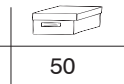
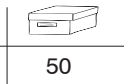

035-178 - CMR

035-207 - CMR

Striking plates

Striking plates

Contro placi

Contro placi

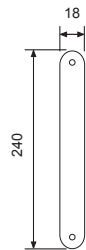
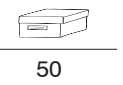
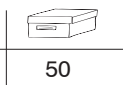



ACCESSORIES FOR SLIDING DOORS ACCESORII PENTRU USI GLISANTE



035-200S - OL

Sliding-door wc lock
with striking plate

*Broasca baie pentru
usi glisante cu tablita*



20

A	B	C	D
50	16	70	100

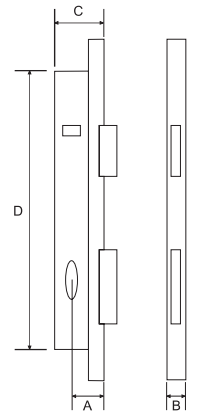

316032P - OL

Pair of inset wc-handles
with pull flush

*Set manere ovale baie pentru
usi glisante cu elem.tragere*



20

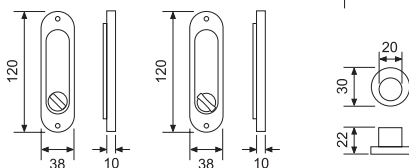

OLV OC OCS OBG

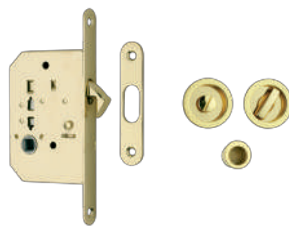

035-200SR - OL

kit of sliding-door wc lock
with inset handles and striking plate

*Set broasca baie cu tablita, manere
si element tragere pentru usi glisanteusi*



20



316032R - OL

316039R - OL

Pair of inset wc-handles
with pull flush

*Set manere rotunde baie pentru
usi glisante cu elem.tragere*



20

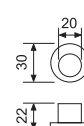
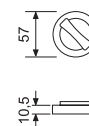
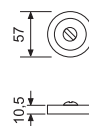



ACCESSORIES FOR SLIDING DOORS ACCESORII PENTRU USI GLISANTE

SERIA USI GLISANTE SLIDING DOORS LINE



035-201S - OL

sliding-door wc lock
with striking plate

*broasca baie pentru
usi glisante cu tablita*



20

A	B	C	D
50	16	70	100

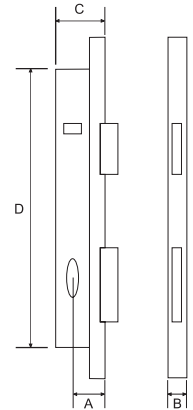

035-201SR - OL

kit of sliding-door patent lock
with inset handles and striking plate

*Set broasca cu tablita, manere
si element tragere pentru usi glisante*



20



316031P - OL

Pair of inset wc-handles
with pull flush

*Set manere ovale cheie pentru
usi glisante cu elem.tragere*



20

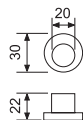
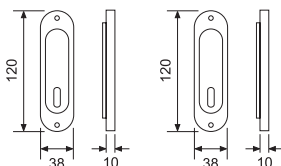

316031R - OL

Pair of inset wc-handles
with pull flush

*set manere rotunde cheie pentru
usi glisante cu elem.tragere*



20

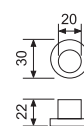
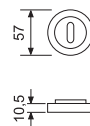
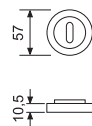

OLV OC OCS OBG



ACCESSORIES FOR SLIDING DOORS ACCESORII PENTRU USI GLISANTE



035-200S - CS

Sliding-door wc lock
with striking plate

*Broasca baie pentru
usi glisante cu tablita*



20

A	B	C	D
50	16	70	100

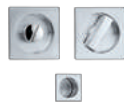
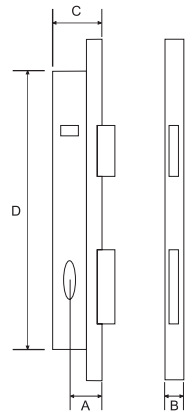

035-200SQ - CS

Kit of sliding-door wc lock
with inset handles and striking plate

*Set broasca baie cu tablita, manere
si element tragere pentru usi glisante*



20



316032Q - CS

316039Q - CS

Pair of inset
wc-handles

*Set manere rotunde
baie pentru usi glisante*



20



OC



OCS



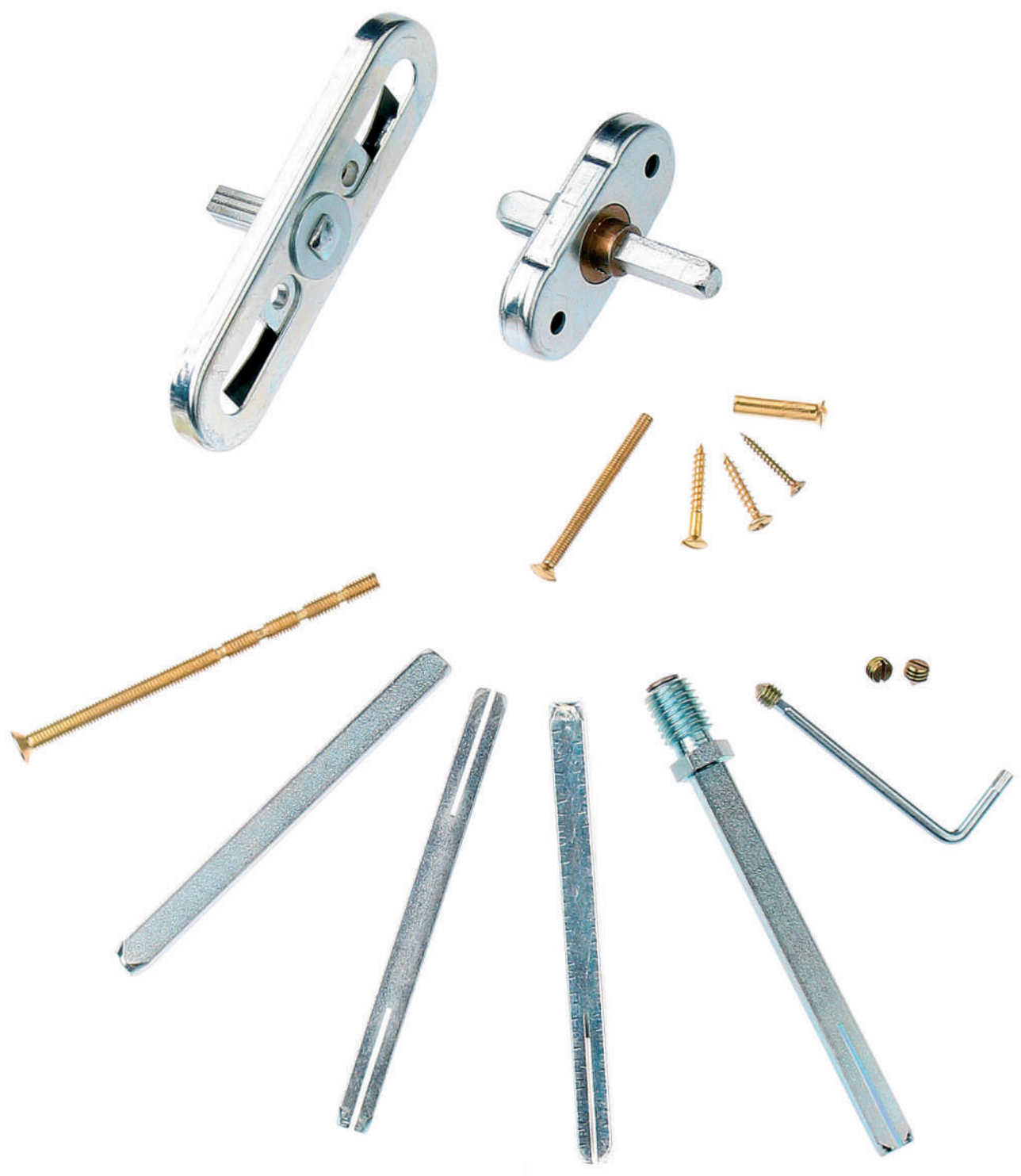

GENERAL SALES RULES

ORDERS

The following sales conditions rule over all the orders accepted by SC VEROFER SRL.

TRANSPORT

The transport company assumes its responsibility for all the risks and all the threats that occurs during the transport process even if our company organises the spediton directly to our customers by using a third transport company. SC VEROFER SRL does not assume its responsibility for eventual delays caused by the transport companies.

CLAIMS

In case of eventual claims our company must be informed in maximum 10 days after the checking on delivery.

We do not accept returns of the goods that were delivered according to the original order that we received from our customer. In any case when a client want to return a quantity of goods, the list of the goods to be returned must be accepted in advance by SC VEROFER SRL.

GUARANTEE

With the present SC VEROFER SRL guarantees that all its production programe is controled against the vices of production process. This mentioned guarantee is limited to the duty of SC VEROFER SRL to replace the goods that it recognize as having deficiencies without any other responsibility.

TERMS OF DELIVERY

The eventual delays in delivery do not give to our customers the right to pretend any reparation.

PRODUCT

The information contained inside this catalogue is approximate.

SC VEROFER SRL reserves his rights to improve the characteristics of its goods relative to the continue technical evolution.

DISPUTES

Any eventual dispute concerning the delivered goods or concerning our agreement will be judged by the instance court of ARAD.

CONDITII GENERALE DE VANZARE

COMENZI

Condițiile prezentate mai jos se aplică tuturor comenzilor acceptate de către SC VEROFER SRL.

TRANSPORT

Transportatorul răspunde pentru eventualele riscuri și pericole survenite pe parcursul transportului chiar și atunci când expedierea este făcută de către firma noastră la adresa beneficiarului prin intermediul unui terț transportator.

SC VEROFER SRL nu răspunde pentru întârzierile la livrare datorate transportatorilor.

EVENTUALE RECLAMAȚII

Eventualele reclamații trebuie transmise în scris în cel mult 10 zile de la recepționarea mărfii de către beneficiar.

Nu se acceptă restituiri de marfă atunci când livrarea a fost făcută de către furnizor conform comenzii inițiale a beneficiarului. In orice situație în care se dorește efectuarea unui retur de marfă, lista cu produsele returnate trebuie acceptată în prealabil de către SC VEROFER SRL.

GARANȚII

SC VEROFER SRL garantează pe această cale că toate produsele realizate sunt verificate împotriva viciilor ce pot surveni pe parcursul procesului de producție.

Garanția anterior menționată se exercită prin înlocuirea produsului recunoscut de către noi ca fiind defect fără a atrage în astfel de cazuri acordarea unor eventuale despăgubiri.

TERMENE DE LIVRARE

SC VEROFER SRL nu acordă garanții generale de nici o natură în ceea ce privește termenele de livrare. Eventualele întârzieri nu conferă dreptul beneficiarului de a pretinde despăgubiri indiferent de natura acestora.

PRODUS

Informațiile conținute în acest catalog sunt furnizate cu titlu informativ.

SC VEROFER SRL își rezervă dreptul de a ameliora fără preaviz caracteristicile produselor sale în funcție de permanenta evoluție tehnologică.

LITIGII

Soluționarea tuturor eventualelor litigii referitoare la marfă sau la contractul de colaborare este de competența instanței judecătorești din Arad.



The companies Binalia - Verofer
reserve the right to change products
specifications without prior notice.
Descriptions, photos, colours and product
sizes are not binding.

Comaniile Verofer si Binalia
*isi rezerva dreptul de a actualiza
specificatiile tehnice din prezentul catalog
fara o informare in prealabil.*



MADE IN EU