

CATALOGUE 2022



**Verofer**<sup>®</sup>

Cylinders and  
Complements

 **BINALIA**<sup>®</sup>

Handles & Accessories



MADE IN EU



**SC BINALIA SRL:** at the beginning of the nineties of last century, Binalia was already working brass manufactures, and it was taken from a group of European entrepreneurs, who, in their original nations, praised solid experiences in the specific sector. Between these entrepreneurs there were persons engaged as much as in the production and in the marketing of those goods. The common research of new business opportunity was the glue for their different experiences. In that period the company knew a thorough renovation, and it was endowed of cutting edge machineries conducted by specialized technical. Beginning from the first years of the new millennium the company is the leading actor as much as corporate structures changes and a redefinition of its own core business: from a subject acting on behalf of third parties to a company with its own range of products for doors and windows, ranging over brass and other raw materials.

In the next months, the productive ways of Binalia and Verofer will join, to create an unique business reality able to purpose on the market as absolute protagonist in its sector.

Always paying attention to the requests of the costumers, we could better head the chance in the domestic and foreign market, combining the energy of the staff both of Verofer and Binalia.

The hallmark of our products is the full respect of the European standards of quality, security and design. It is no coincidence, for example, that our cylinders are completely realized in brass, with raw material certificate EN 10 204 2.2 and have implemented a quality system ISO 9001:2008.

A large range of our production is realized in brass, alloy of copper and zinc, which is easy to mold and hard proof to corrosion, while our manufactures in zamak respect the European standard as 410 EN1774 and are ermined with copper, which isolates and protects against corrosive agents.

Protagonists from years on the international market as well as on the Romanian market, for Binalia and Verofer, during their diversified production history, the respect of costumers has been their qualifying point. The companies succeeded by achieving productive performances, where the quality of production is combined with style and good functionality of the various range of goods which gives birth to the new catalogue we are pleased to present.

To celebrate the 30th anniversary of our foundation, we created a modern website where you can find technical and specific information about every product.



**SC VEROFER SRL:** Verofer was founded at the end of the nineties of last century, from a group of entrepreneurs both Romanians and Italians, who were able to count on the experience of Mr Vercellini, the majority shareholder, working from long time in the metal mechanical environment. He, and his staff, planned the diversification of the productions, adding to the traditional line of handles and locks even the line of security cylinders, to offer to the costumers a diversified fan of goods dedicated at the security of buildings. In the years, the productive flairs of Mr Vercellini have favored the emergence of synergies with European companies (leaders in the industry of doors and windows), which praise a specialization both in the realization of hinges for doors, anodized handles, high system of locks, and in the innovative sector of the sliding doors.



**SC.Binalia SRL:** Cu o prezență activă în domeniul producerii de articole, Binalia a fost înființată la începutul anilor '90 ai secolului trecut de către un grup de antreprenori europeni care aveau deja avantajul unei experiențe solide, cu precădere în sectorul realizării produselor din alamă dar și în domeniul comercializării acestora. Modalitatea optimă de a fructifica sinergia diverselor experiențe era aceea de a porni împreună spre căutarea unor noi oportunități de business.

În acea perioadă renaște o profundă restructurare a firmei prin implementarea unor tehnologii de avangardă puse în operă de un personal specializat.

În primii ani ai noului mileniu Binalia a cunoscut modificări atât în structura acționariatului dar mai ales și-a redefinit propriul core business trecând de la etapa în care realiza produse la cererea firmelor partenere la definirea unei game proprii de articole pentru uși și ferestre realizate atât din alamă cât și din zamac.

Pe parcursul următoarelor luni, Binalia și Verofer își vor unifica departamentele de producție, cu scopul de a da viață unei unice realități corporative capabilă să se impună pe piață ca un adevărat lider al branșei pe care activează.

Dintotdeauna atenți la exigențele clienților noștri și cumulând energiile partenerilor noștri strategici cu specializarea personalului tehnic provenit atât din Binalia cât și din Verofer vom putea înfrunta cu forță maximă provocările pe care ni le adresează piața indigenă dar și cea internațională.

Semnul distinctiv al produselor noastre îl constituie deplinul respect al standardelor europene de calitate, siguranță și design. Astfel în mod deosebit cilindri noștri sunt realizați în întregime din alamă, utilizând materie primă certificată EN 10 204 2.2 și având implementat un sistem de management al calității ISO 9001:2008.

Mare parte dintre produsele noastre sunt realizate din alamă, aliaj de cupru și zinc, ceea ce permite deopotrivă o prelucrare facilă și o rezistență crescută la coroziune, în timp ce articolele din zamac respecta normele europene 410 EN 1774 și sunt supuse unui tratament galvanic care le protejează de acțiunea agenților corozivi.

Prezente ca protagoniste atât pe piața internă dar și pe cea internațională, Binalia și Verofer - de-a lungul bogatei lor istorii productive - au transformat respectul față de client într-un element definitoriu, având ca scop atingerea unei performanțe productive prin care calitatea procesului de producție se combină cu stilul și funcționalitatea bogatei game de produse care au dat naștere acestui nou catalog pe care ne face plăcere să vi-l prezentăm.

Cu ocazia aniversării a 30 de ani de activitate, firmele noastre întâmpina clienții online cu un nou site web, modern, ușor de consultat și bogat în date tehnice specifice fiecărui articol.



**SC Verofer SRL:** Infintata la sfarsitul anilor '90 de un grup de investitori de origine italiana si română care au contat pe experiența lui Girolamo Vercellini, acționar majoritar, care a planificat diversificarea gamei de produse prin completarea gamei tradiționale de articole din alamă și zamac cu cilindri de siguranță, din preocuparea de a oferi clientei o gama cât mai variată de articole dedicate siguranței clădirilor civile, comerciale și industriale. Intuițiile productive ale lui Vercellini au favorizat de-a lungul timpului nașterea unor sinergii cu alte firme europene (lideri în sectorul de feronerie pentru uși și ferestre), în special italiene, specializate la rândul lor în producerea unor sisteme inovative de glisare, realizarea de balamale cilindrice, producerea manerelor din aluminiu anodizat etc.



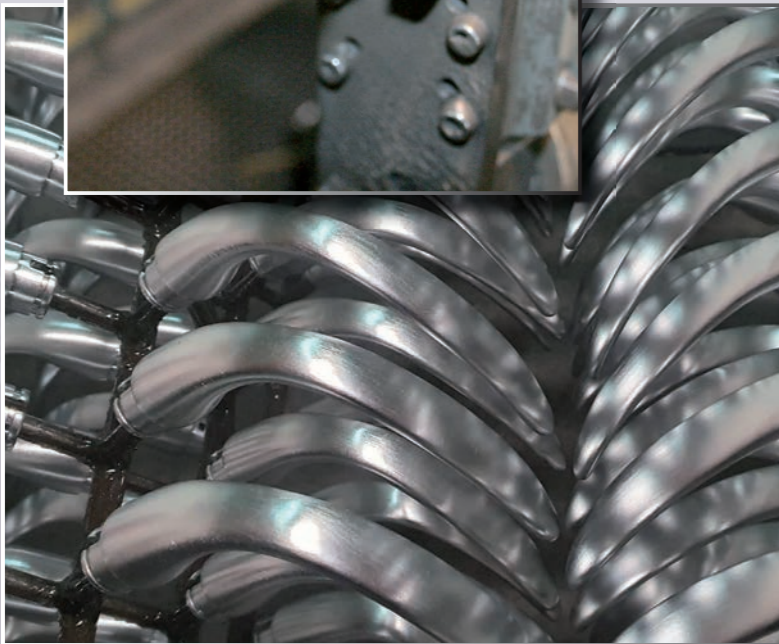
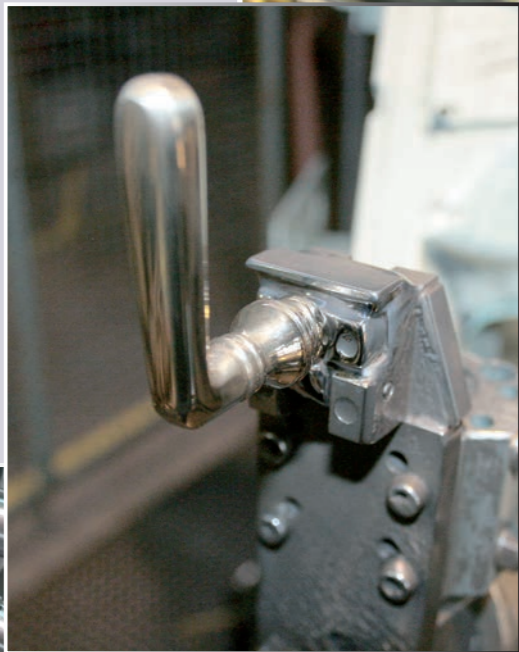
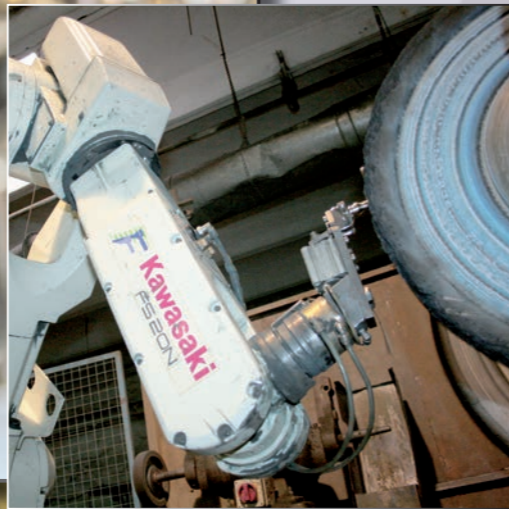

BRESCIA - ITALY

+39 0365 88052



ARAD - ROMANIA

+40 257 270 999



ARAD - ROMANIA

+40 257 289 734



## CERTIFICATE

BINALIA SRL has obtained the certification for conformity of Management System according to the UNI EN ISO 9001: 2008

*sc BINALIA SRL detine certificarea Sistemului de Management in conformitate standardul UNI EN ISO 9001: 2008*



“Non chiesi al mio datore di lavoro il salario che mi avrebbe dato o il lavoro che avrei dovuto fare, non mi interessava: l’unica cosa che mi interessava era cambiare la mia vita.

Così come le mie aziende trasformano materie prime per produrre cilindri e maniglie per porte, così la mia intraprendenza ha saputo trasformare i sacrifici fatti nella consapevolezza che ogni meta è raggiungibile.”













*Girolamo Vercellini*

**BINALIA**<sup>®</sup>  
Handles & Accessories



## MATERIALS & FINISHING

### BRASS ZAMAK STEEL

	POLISHED BRASS <i>ALAMA LUCIOS</i>	OLV	ZOL	-
	SATIN BRASS <i>ALAMA SATINAT</i>	OSV	-	-
	BRONZED BRASS <i>ALAMA BRONZAT</i>	OBV	-	-
	SCRATCHED BRONZE <i>BRONZAT GRAFIAT</i>	OBG	ZBG	-
	BRONZE MATT <i>BRONZAT MAT</i>	OBY	-	-
	ANTIQUE BRASS <i>ALAMA ANTIK</i>	OBA	-	-
	POLISHED CHROME <i>CROM LUCIOS</i>	OCL	ZCL	CL
	CHROME SATIN <i>CROM SATINAT</i>	OCS	ZCS	CS
	NICKEL SATIN <i>NICKEL SATINAT</i>	ONS	ZNS	-
	POLISHED STAINLESS STEEL <i>INOX LUCIOS</i>	-	-	INOX
	SATIN STAINLESS STEEL <i>INOX SATINAT</i>	-	-	INOX SAT
	BLACK <i>NEGRU</i>	RAL 9005	A-Z-OJ	-

### ALLUMINIUM

	ANODIZED SILVER <i>ANODIZAT ARGINTIU</i>	F1A			GOLDEN PAINT <i>VOPSIT AURIU</i>	F6A
	ANODIZED BRONZE <i>ANODIZAT BRONZAT</i>	F4A			WHITE <i>ALB</i>	A-Z
	SILVERED PAINT <i>VOPSIT ARGINTIU</i>	F5A			BROWN <i>MARO</i>	A

## VINTAGE

FROM NOW AVAILABLE FOR ALL THE RANGE BRASS LINE



 WIEN

21292P - OBA

▶ page 41

ANTIQUE BRASS  
ALAMA ANTIK



## DI TENDENZA

FROM NOW AVAILABLE FOR ALL THE ZINC RANGE

 DIANA

23080R08 - RAL 9005



▶ page 15

NEW FINISHING



Q - LINE SERIA Q

	CLIO	PAG. 18
	DIANA	PAG. 15
	ELISA	PAG. 14
	GIUSSY	PAG. 16



	LUNA	PAG. 12
	MANHATTAN	PAG. 13
	NEW PRAGUE	PAG. 17
	VITTORIA	PAG. 18

BRASS LINE SERIA ALAMA

	ALICANTE	PAG. 22
	ALT WIEN	PAG. 40
	ALTEA	PAG. 21
	AMBRA	PAG. 35
	ATENA	PAG. 36
	BETA	PAG. 42
	CLAUDIA	PAG. 41
	COMBI	PAG. 47
	COSMO	PAG. 45
	ELEGANT	PAG. 37
	EMMA	PAG. 16
	EXPO	PAG. 12
	FIORE	PAG. 23
	GAYA	PAG. 33
	GIULIA	PAG. 31
	GRANADA	PAG. 34
	ISEO	PAG. 35

	KATY	PAG. 28
	LUXOR	PAG. 20
	LYUBA	PAG. 47
	MADEIRA	PAG. 22
	MAURA	PAG. 27
	NINFEA	PAG. 32
	ONDA	PAG. 29
	PANDA	PAG. 43
	PAPERINO	PAG. 47
	SIMONA	PAG. 46
	TOLOSA	PAG. 24
	TEKNA	PAG. 19
	TRENDY	PAG. 30
	VENUS	PAG. 25
	VIENNETTA	PAG. 40
	WIEN	PAG. 41
	WING	PAG. 44

SECURITY LINE SERIA SECURITY

	BERLINO	PAG. 71
	GOLF	PAG. 26
	LAURA	PAG. 51

	PARIGI	PAG. 72
	PARIGI DEC	PAG. 72
	VICTORIAN	PAG. 71

ZINC LINE SERIA ZINC

	AMBRA ECO	PAG. 54
	AMBRA ECO MINUS	PAG. 57
	BETA ECO	PAG. 55
	CARINA	PAG. 52
	ISCHIA	PAG. 56
	MAREA	PAG. 53
	MARGARET	PAG. 51
	MONICA	PAG. 53
	RIO	PAG. 58
	ROBY	PAG. 51
	SOFIA	PAG. 58
	VIENNETTA ECO	PAG. 57

ACCESSORIES LINE SERIA ACCESORII

PAG. 63/76

CYLINDERS LINE SERIA CILINDRI

PAG. 78/90

**EUROPEAN PROFILE CYLINDERS**  
CILINDRI PROFIL EUROPEAN

**SECURITY CYLINDERS WITH REVERSIBLE KEYS**  
CILINDRI DE SIGURANTA CU CHEI REVERSIBILE

**BATHROOM CYLINDERS & THUMBTURN**  
CILINDRI CU BUTON PENTRU BAIE

**CYLINDERS & THUMBTURN - 3 KEYS**  
CILINDRI CU BUTON & CHEI

**SINGLE CYLINDERS & THUMBTURN**  
SEMICILINDRI CU BUTON





**SINGLE CYLINDERS & KEYS**  
SEMICILINDRI & CHEI

**SPECIAL APPLICATIONS**  
APPLICATII SPECIALE



LOCKS LINE SERIA BROASTE

035-29	PAG. 93
035-59	PAG. 98
035-91	PAG. 96
035-96	PAG. 97
035-154	PAG. 94
035-171L	PAG. 98
035-174	PAG. 95
035-178	PAG. 99
035-183	PAG. 98
035-199	PAG. 92
035-204	PAG. 99
035-207	PAG. 99
035-210	PAG. 99

ALLUMINIUM LINE SERIA ALUMINIU

	25164P	PAG. 61
	ARAD	PAG. 60
	MURES	PAG. 60
	VENERA	PAG. 61

INOX LINE SERIA INOX

	NOVANTA	PAG. 62
	U	PAG. 62

SLIDING DOORS LINE

SERIA USI GLISANTE

PAG. 100/102

COMPONENTS COMPONENTE

PAG. 103





**EXPO** ZCS ZCL RAL 9005



**LUNA** ZCS ZNS ZCL RAL 9005



**23088R08 - ZCS**  
Handle on rose  
Maner cu rozeta

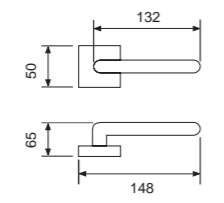

**23088DK - ZCS**  
Tilt and turn handle  
DK

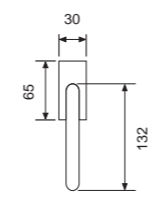

**23084R08 - ZCS**  
Handle on rose  
Maner cu rozeta

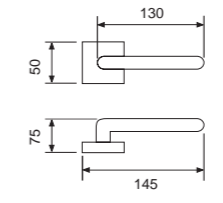

**23084DK - ZCS**  
Tilt and turn handle  
DK

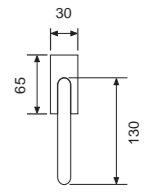





Design: **Studio.Gea.Italia**

**ELISA**

ZCS ZNS ZCL RAL 9005



Design: **Studio.Gea.Italia**

**DIANA**

ZCS ZNS ZCL RAL 9005



**23081R08 - ZCS**  
Handle on rose  
*Maner cu rozeta*

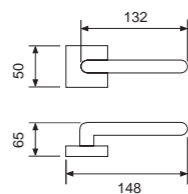

**33081DK - ZCS**  
Tilt and turn handle  
*DK*

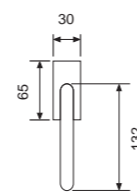

**23080R08 - RAL 9005**  
Handle on rose  
*Maner cu rozeta*

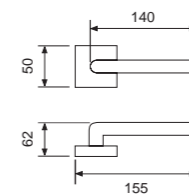

**33080DK - RAL 9005**  
Tilt and turn handle  
*DK*

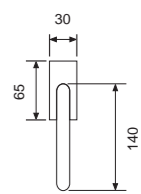





Design: **Studio.Gea.Italia**

**EMMA**

ZCS ZCL RAL 9005

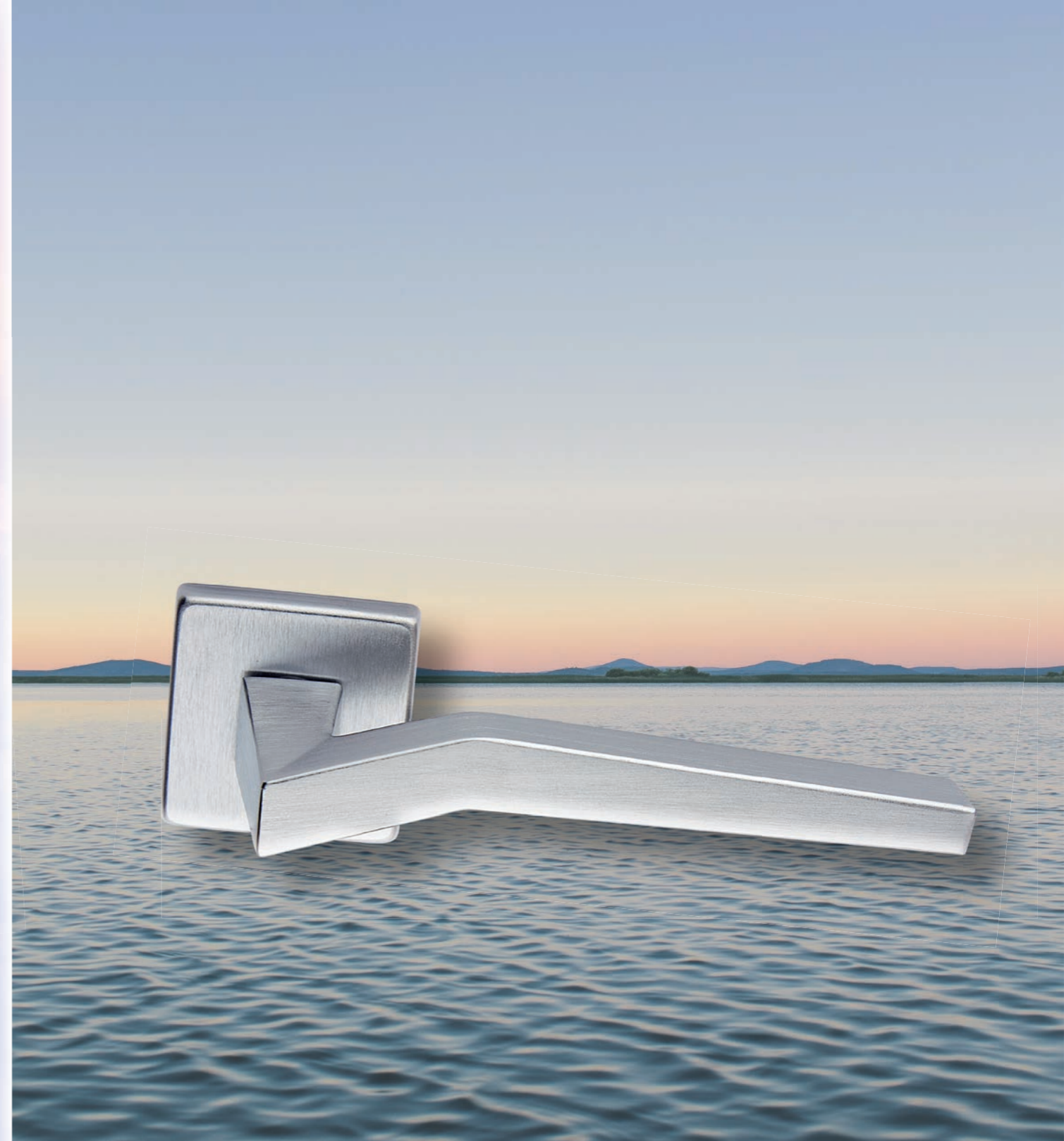

**NEW PRAGUE**

ZCS ZNS ZCL/ZCS RAL 9005



**23086R08F - ZCS**  
Handle on rose  
*Maner cu rozeta*

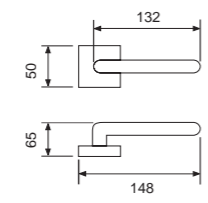

**23086DK - ZCS**  
Tilt and turn handle  
*DK*

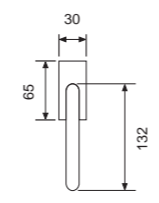

**23070R08 - ZCS**  
Handle on rose  
*Maner cu rozeta*

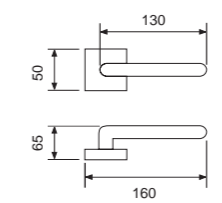

**33070DK - ZCS**  
Tilt and turn handle  
*DK*

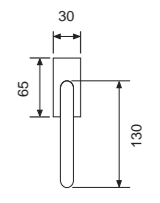



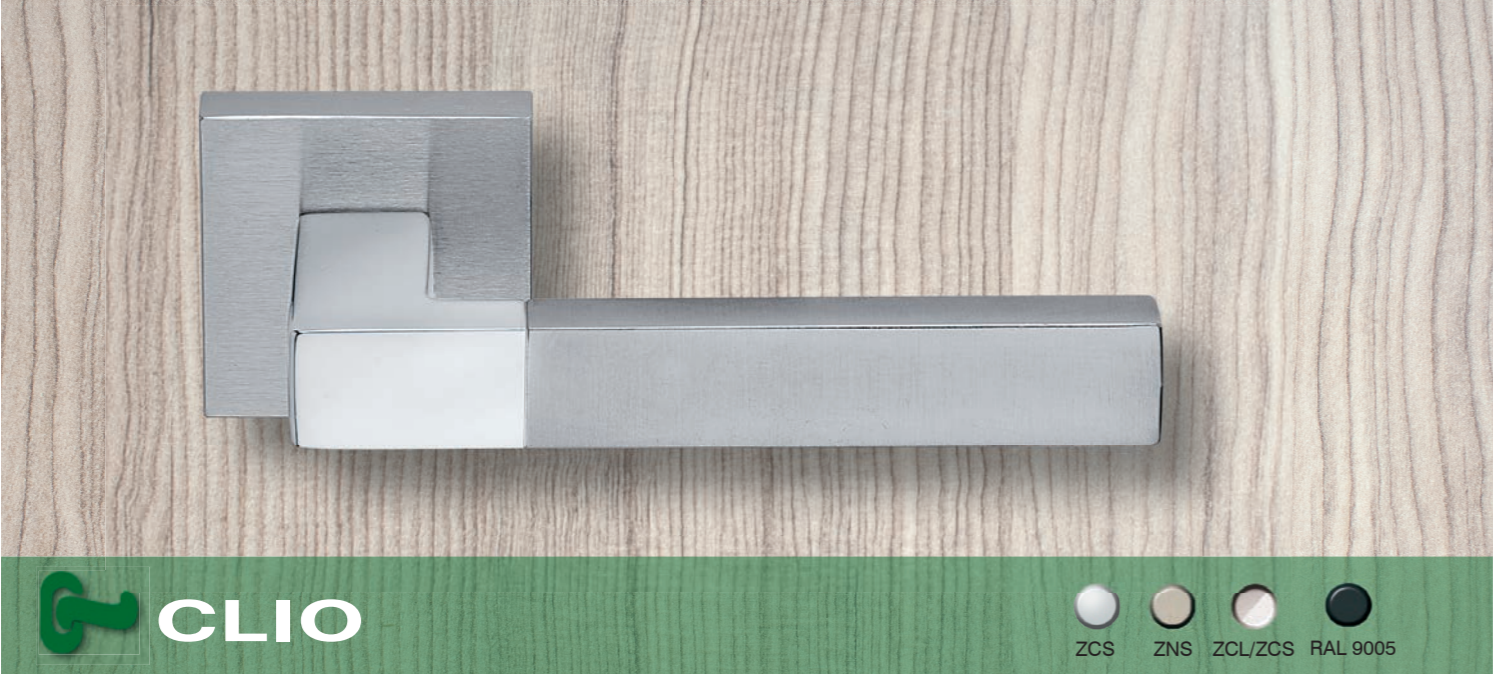

**CLIO**

ZCS ZNS ZCL/ZCS RAL 9005



**TEKNA**

ZCS ZNS RAL 9005

**23061R08 - ZCL/ZCS**  
Handle on rose  
*Maner cu rozeta*

**33061DK - ZCS**  
Tilt and turn handle  
*DK*

**23085R08 - ZCS**  
Handle on rose  
*Maner cu rozeta*

**23085DK - ZCS**  
Tilt and turn handle  
*DK*



**VITTORIA**

ZCS ZNS ZC/LZCS RAL 9005



**GIUSSY**

ZCS ZNS ZCL/ZCS RAL 9005

**23013R08 - ZCS**  
Handle on rose  
*Maner cu rozeta*

**23013DK - ZCS**  
Tilt and turn handle  
*DK*

**23063R08 - ZCL/ZCS**  
Handle on rose  
*Maner cu rozeta*

**33063DK - ZCS**  
Tilt and turn handle  
*DK*





**21200R09 - OBG**  
Handle on rose  
*Maner cu rozeta*

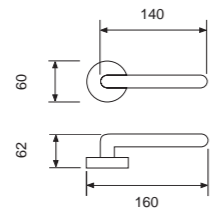

**21200P - OBG**  
Handle on plate  
*Maner cu placa*

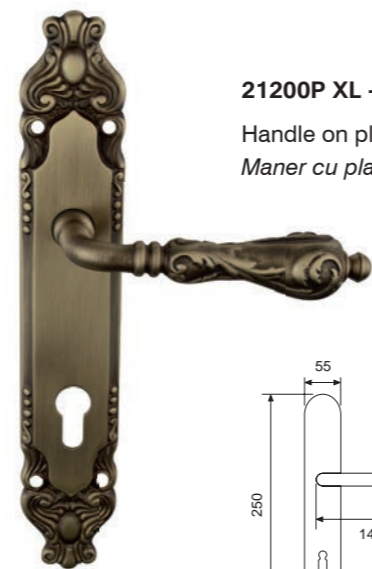
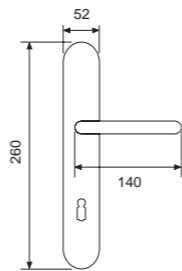

**21200P XL - OBG**  
Handle on plate  
*Maner cu placa*

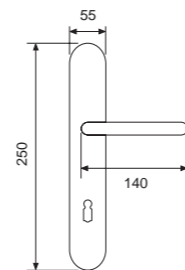

**31200DK - OBG**  
Tilt and turn handle  
*DK*

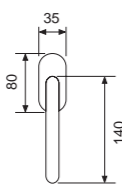

**21070R04 - OBG**  
Handle on rose  
*Maner cu rozeta*

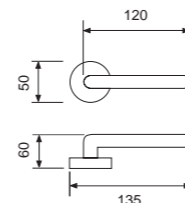

**21070P - OBG**  
Handle on plate  
*Maner cu placa*

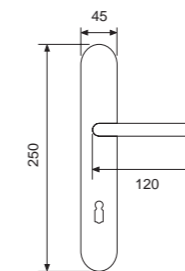

**2070 - OBG**  
Window's plate on handle  
*Miner cu sild pt fereastr*

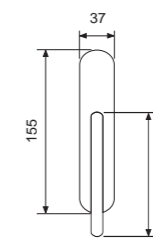

LEFT

RIGHT



**31070DK - OBG**  
Tilt and turn handle  
*DK*

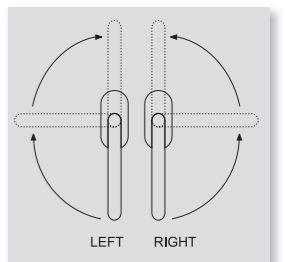
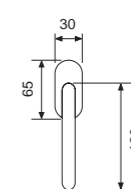

Please specify when is LEFT  
*Precizati Dreapta sau Stanga*







**MADEIRA**

21094P - OBG

Handle on plate  
Maner cu placa

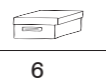

6

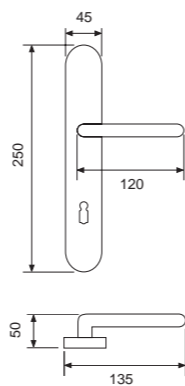

**ALICANTE**

21079P - OBG

Handle on plate  
Maner cu placa

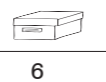

6

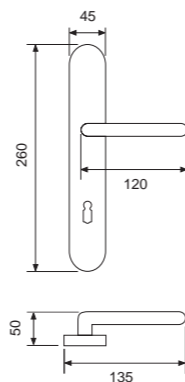

**FIORE**



21088R03 - OBG

Handle on rose  
Maner cu rozeta

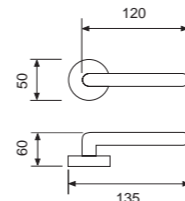

21088P - OBG

Handle on plate  
Maner cu placa

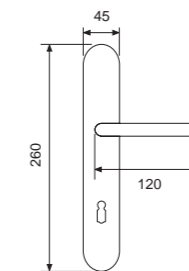

LEFT

RIGHT



31088DK - OBG

Tilt and turn handle  
DK

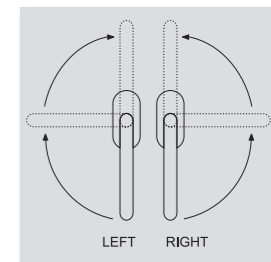
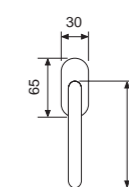

Please specify when is LEFT  
Precizati Dreapta sau Stanga





**TOLOSA**

OLV/OSV OBG ONS

**VENUS**

OLV OBG



**21058R03 - OBG**  
Handle on rose  
*Maner cu rozeta*

**21058P - OBG**  
Handle on plate  
*Maner cu placa*

**2058 - OBG**  
Window handle  
*Cremon*

**31058DK - OBG**  
Tilt and turn handle  
*DK*

**21034R04 - OGR**  
Handle on rose  
*Maner cu rozeta*

**21034P - OBG**  
Handle on plate  
*Maner cu placa*

**2034 - OBG**  
Window's plate on handle  
*Miner cu sild pt fereastr*

**31034DK - OBG**  
Tilt and turn handle  
*DK*

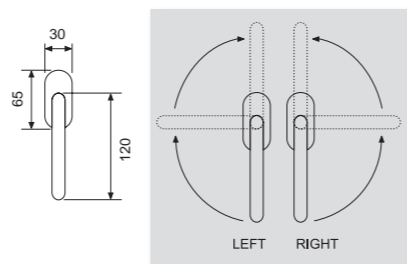
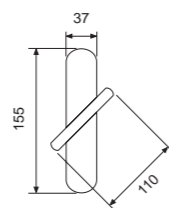
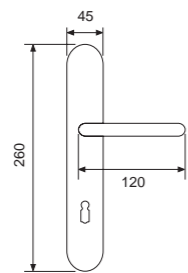
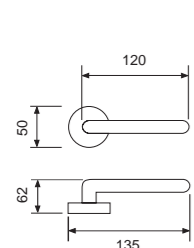

Please specify when is LEFT  
*Precizati Dreapta sau Stanga*

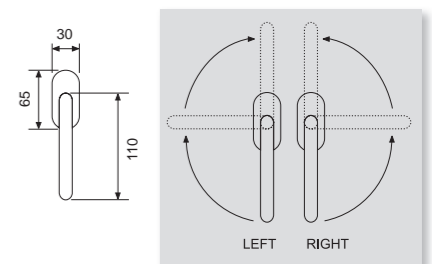
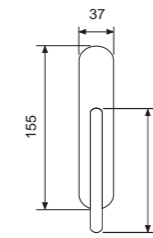
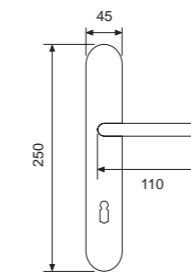
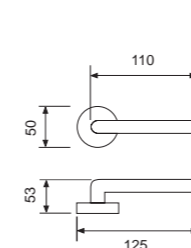

Please specify when is LEFT  
*Precizati Dreapta sau Stanga*





**GOLF**



**23998R03 - ZCS**  
Handle on rose  
Maner cu rozeta

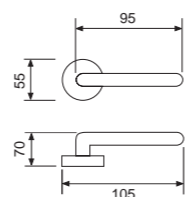

**MAURA**

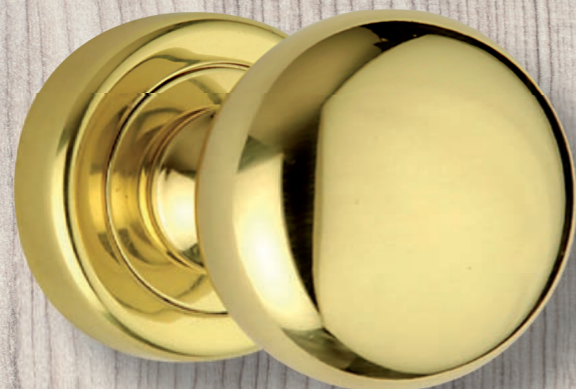

**VICTORIAN**



**21808R03 - OLV**  
Handle on rose  
Maner cu rozeta

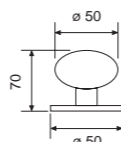

**21064R03 - OLV**  
Handle on rose  
Maner cu rozeta

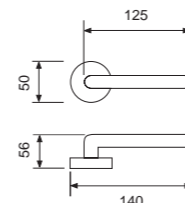

**21064P - OLV**  
Handle on plate  
Maner cu placa

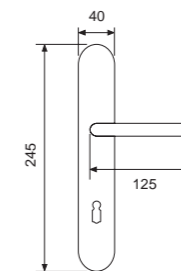

LEFT RIGHT



**31064DK - OLV**  
Tilt and turn handle  
DK

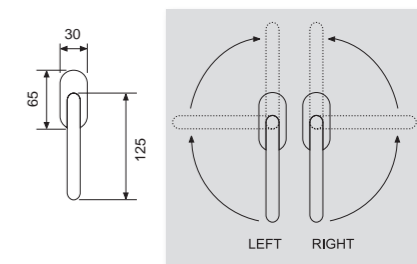

Please specify when is LEFT  
Precizati Dreapta sau Stanga



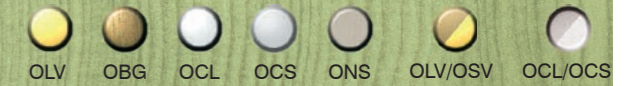

**21077R04 - OLV**  
Handle on rose  
*Maner cu rozeta*

**21077P - OLV**  
Handle on plate  
*Maner cu placa*

**2077 - OLV**  
Window's plate on handle  
*Miner cu sild pt fereastra*

**31077DK - OLV**  
Tilt and turn handle  
*DK*

**21072R04 - OCL/OCS**  
Handle on rose  
*Maner cu rozeta*

**21072P - OCL/OCS**  
Handle on plate  
*Maner cu placa*

**31072DK - OCL/OCS**  
Tilt and turn handle  
*DK*

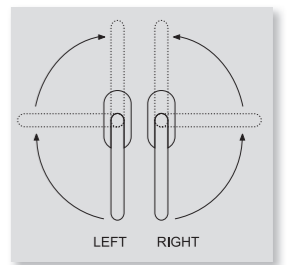
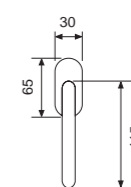
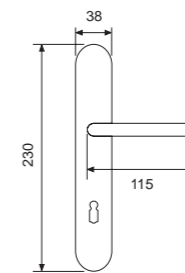
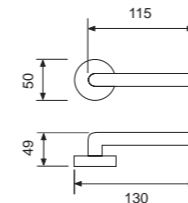
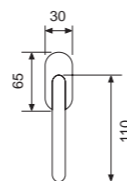
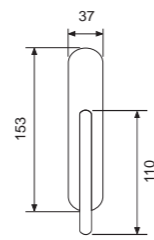
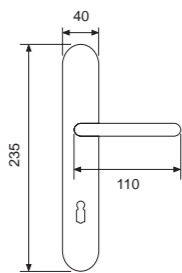
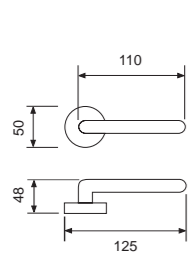

Please specify when is LEFT  
*Precizati Dreapta sau Stanga*





**TRENDY**

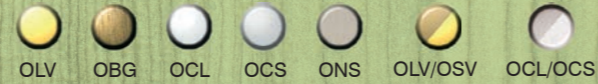

**GIULIA**



**21075R03 - OCL/OCS**  
Handle on rose  
*Maner cu rozeta*

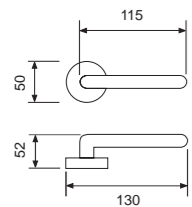

**21075P - OCL/OCS**  
Handle on plate  
*Maner cu placa*

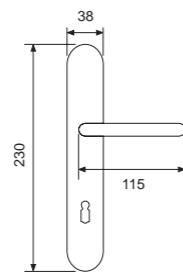

**31075DK - OCL/OCS**  
Tilt and turn handle  
*DK*

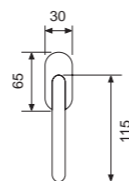

**21069R04 - OCS**  
Handle on rose  
*Maner cu rozeta*

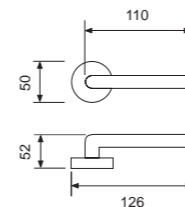

**21069P - OCS**  
Handle on plate  
*Maner cu placa*

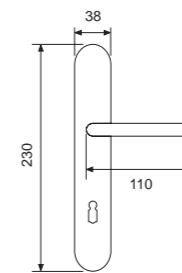

LEFT RIGHT



**31069DK - OCS**  
Tilt and turn handle  
*DK*

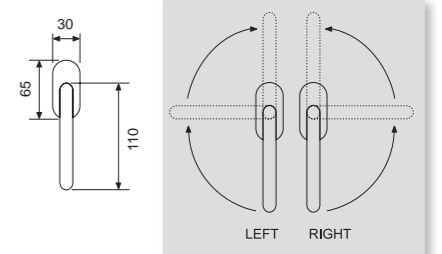

Please specify when is LEFT  
*Precizati Dreapta sau Stanga*





**21089R04 - OCS**  
Handle on rose  
*Maner cu rozeta*

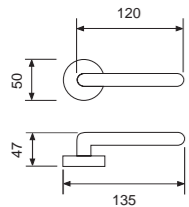

**21089P - OCS**  
Handle on plate  
*Maner cu placa*

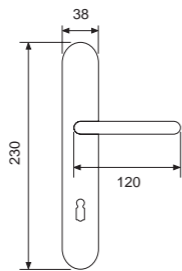

LEFT RIGHT



**31089DK - OCS**  
Tilt and turn handle  
*DK*

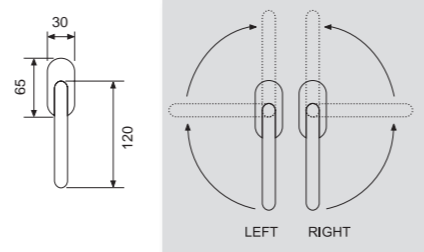

Please specify when is LEFT  
*Precizati Dreapta sau Stanga*



**21022R03 - OLV**  
Handle on rose  
*Maner cu rozeta*

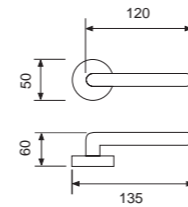

**21022P - OLV**  
Handle on plate  
*Maner cu placa*

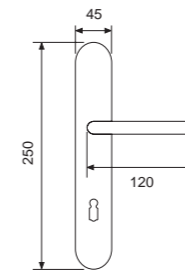

**2022 - OLV**  
Window's plate on handle  
*Miner cu sild pt fereastr*

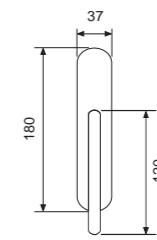

**31022DK - OLV**  
Tilt and turn handle  
*DK*

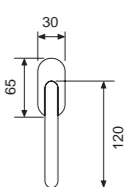



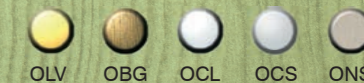

**21018R03 - OLV**  
Handle on rose  
*Maner cu rozeta*

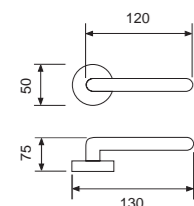

**21018P - OLV**  
Handle on plate  
*Maner cu placa*

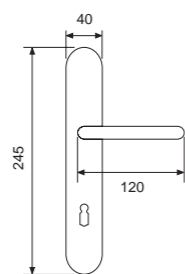

LEFT RIGHT



**31018DK - OLV**  
Tilt and turn handle  
*DK*

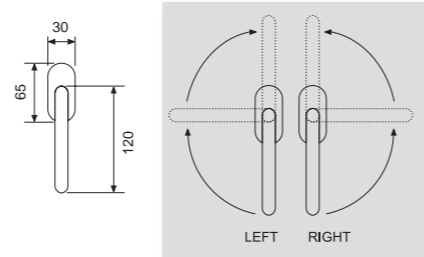

Please specify when is LEFT  
*Precizati Dreapta sau Stanga*



**21020R03 - OLV**  
Handle on rose  
*Maner cu rozeta*

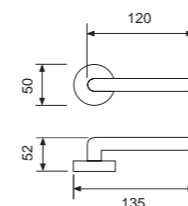

**21020P - OLV**  
Handle on plate  
*Maner cu placa*

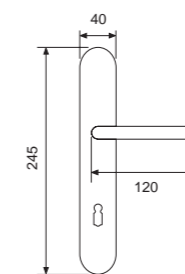

**2020 - OLV**  
Window handle  
*Cremon*

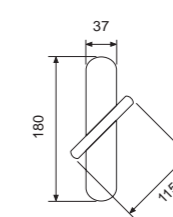

**31020DK - OLV**  
Tilt and turn handle  
*DK*

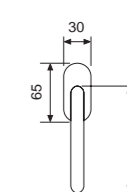





 ISEO

-  OLV
-  OBG
-  OCL
-  OCS
-  ONS

21004R03 - OC/OCS  
Handle with rcv  
Maner cu rozeta filetata

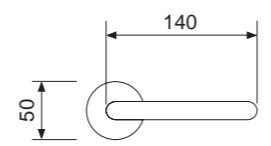

 BINALIA®





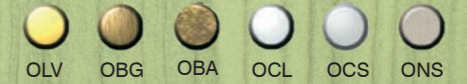

**21016R03 - OCS**  
Handle on rose  
*Maner cu rozeta*

**21016P - OCS**  
Handle on plate  
*Maner cu placa*

**31016DK - OCS**  
Tilt and turn handle  
*DK*

**21078R04 - OLV**  
Handle on rose  
*Maner cu rozeta*

**21078P - OLV**  
Handle on plate  
*Maner cu placa*

**2078 - OLV**  
Window handle  
*Cremon*

**31078DK - OLV**  
Tilt and turn handle  
*DK*

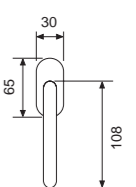
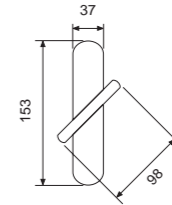
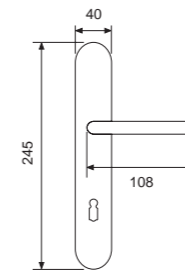
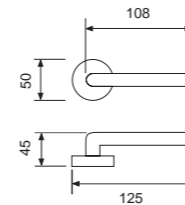
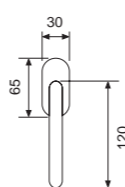
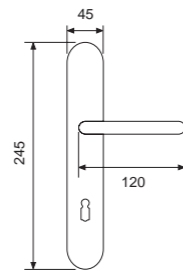
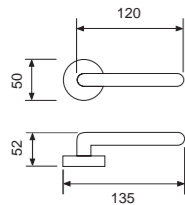



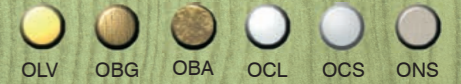

**21192R04 - OLV**  
Handle on rose  
*Maner cu rozeta*

**21192P - OLV**  
Handle on plate  
*Maner cu placa*

**2092 - OLV**  
Window's plate on handle  
*Miner cu sild pt fereastr*

**31192DK - OLV**  
Tilt and turn handle  
*DK*

**21292R04 - OLV**  
Handle on rose  
*Maner cu rozeta*

**21292P - OLV**  
Handle on plate  
*Maner cu placa*

**20292 - OLV**  
Window handle  
*Cremon*

**31292DK - OLV**  
Tilt and turn handle  
*DK*

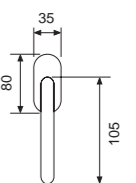
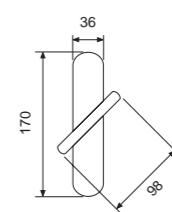
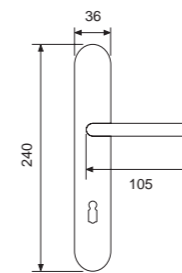
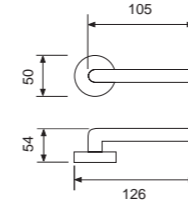
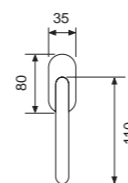
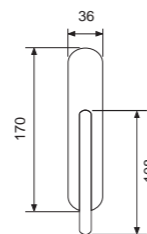
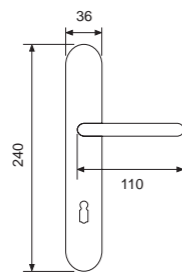
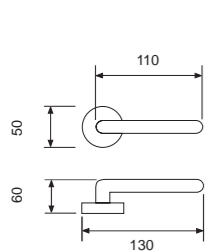





**21026R04 - OLV**  
Handle on rose  
*Maner cu rozeta*

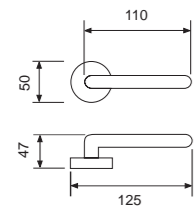

**21026P - OLV**  
Handle on plate  
*Maner cu placa*

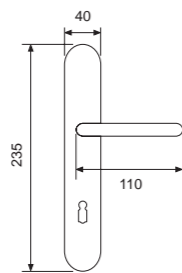

LEFT RIGHT



**31026DK - OLV**  
Tilt and turn handle  
*DK*

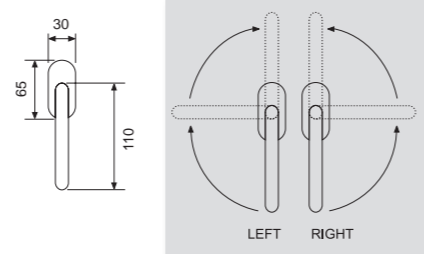

Please specify when is LEFT  
*Precizati Dreapta sau Stanga*



**21052R04 - ONS**  
Handle on rose  
*Maner cu rozeta*

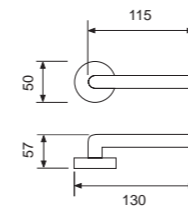

**21052P - ONS**  
Handle on plate  
*Maner cu placa*

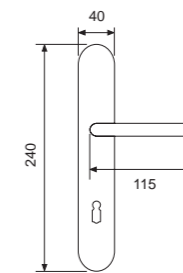

LEFT RIGHT



**31052DK - ONS**  
Tilt and turn handle  
*DK*

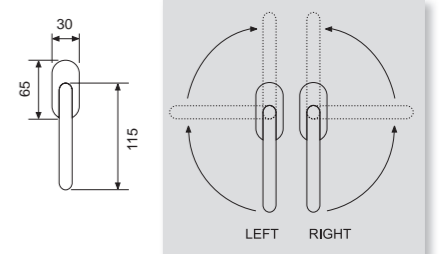

Please specify when is LEFT  
*Precizati Dreapta sau Stanga*





**21024R04 - OLV**  
Handle on rose  
*Maner cu rozeta*

**21024P - OLV**  
Handle on plate  
*Maner cu placa*

**2024 - OLV**  
Window's plate on handle  
*Miner cu sild pt fereastr*

**31024DK - OLV**  
Tilt and turn handle  
*DK*

**21057R04 - OLV**  
Handle on rose  
*Maner cu rozeta*

**21057P - OLV**  
Handle on plate  
*Maner cu placa*

**31057DK - OLV**  
Tilt and turn handle  
*DK*

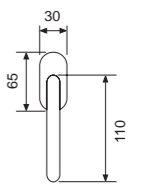
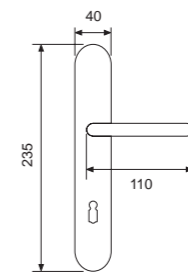
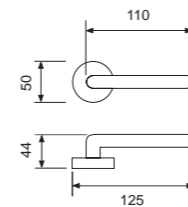
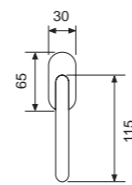
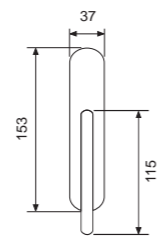
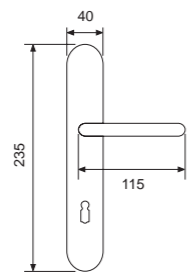
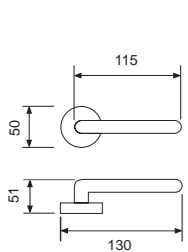





**21023R04 - OLV**  
Handle on rose  
*Maner cu rozeta*

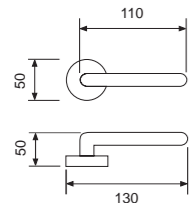

**21023P - OLV**  
Handle on plate  
*Maner cu placa*

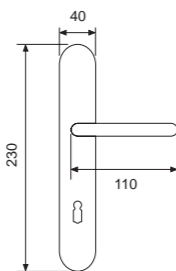

LEFT RIGHT



**31023DK - OLV**  
Tilt and turn handle  
*DK*

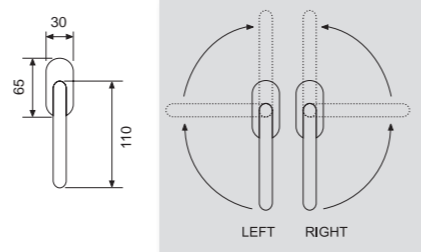

Please specify when is LEFT  
*Precizati Dreapta sau Stanga*



**21080R04 - OBG**  
Handle on rose  
*Maner cu rozeta*

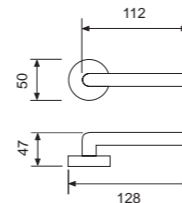

**21080P - OBG**  
Handle on plate  
*Maner cu placa*

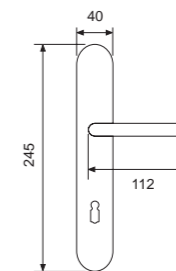

**31080DK - OBG**  
Tilt and turn handle  
*DK*

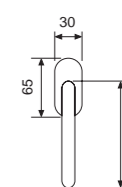





**SIMONA**



**21046R04 - OBV**  
Handle on rose  
*Maner cu rozeta*

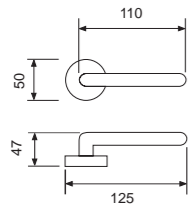

**21046P - OBV**  
Handle on plate  
*Maner cu placa*

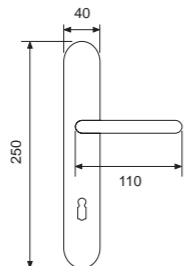

**2046 - OBV**  
Window handle  
*Cremon*

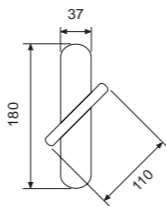

**CLARISSA**

**21048P - OBV**  
Handle on plate  
*Maner cu placa*

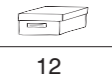

12



OBV

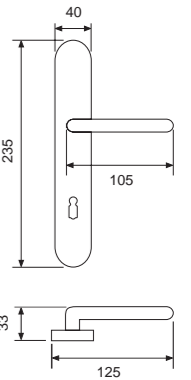

**PAPERINO**

**21044P - OBV**  
Handle on plate  
*Maner cu placa*

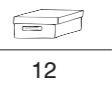

12



OLV



OBV



OBM

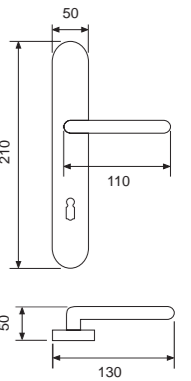

**COMBI**

**21047P - OBV**  
Handle on plate  
*Maner cu placa*

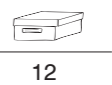

12



OLV



OBV



OBM

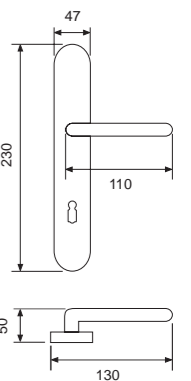







**BERLINO**



**23020R04/B**

\*\*\*23020R04/B CONSISTING IN:

HANDLE WITH ROSE R04  
DOOR KNOB BERLINO ART. 3381R04  
CAN BE FIXED WITH THREADED SCREW  
OR NIPLEX

\*\*\*23020R04/B COMUPUS DIN:

MINER PE ROZETA R04  
CU BUTON TIP BERLINO ART. 3381R04  
POT FI FIXATE CU SURUB FILETAT SAU  
NIPLEX

**Other accessories:**

Nyplex 10 MA  
8x90 mm- 8x100 mm

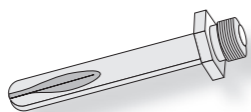

**BLINDO**



**B50Y**

62X82 mm

**B50DM**

62X82 mm

**DEFENDER**



**B52Y**

ø 52 mm - h 12 mm



**TECHNICAL DRAWING TO FIX / INSTRUCTIUNI TEHNICE PENTRU FIXARE**

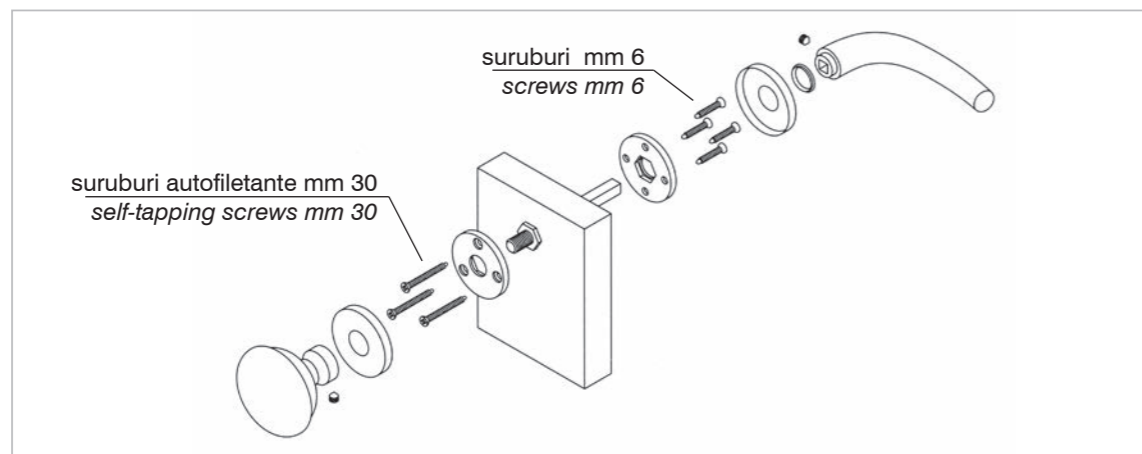

**BRASS PULL-HANDLES  
MANERE TRAGATOARE DIN ALAMA**



**MANHATTAN**

**23082T - OCS**

Pull-handle

Manere tragatoare 1

	A	B
<b>23082T</b>	200	230
<b>28082T</b>	250	280
<b>33082T</b>	300	330
<b>48082T</b>	450	480

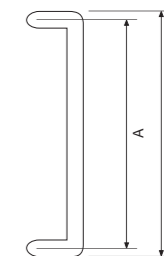

**ELISA**

**31581T - OCS**

Pull-handle

Manere tragatoare 1

	A	B
<b>31581T</b>	160	180
<b>31582T</b>	200	220

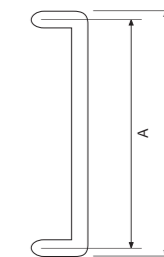









 **LUCIA**

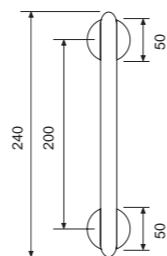

**31507T - OCL/OCS**  
 Pull-handle   
 Manere tragatoare | 1

   
 OLV/OSV OCL/OCS



 **GARDA**

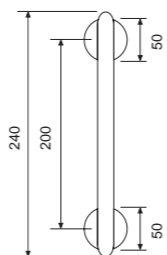

**31510T - OCL/OCS**  
 Pull-handle   
 Manere tragatoare | 1

   
 OLV/OSV OCL/OCS



 **LUXOR**

**315200T - OLV**  
 Pull-handle   
 Manere tragatoare | 1

    
 OLV OBG OBA

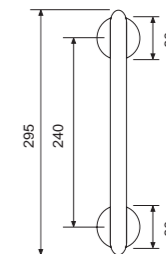





**GRANADA**

**31518T - OLV**  
Pull-handle  
Manere tragatoare | 1

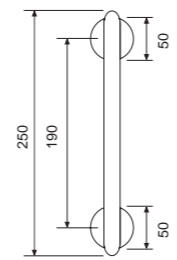

**MADRID**

**31532T - OLV**  
Pull-handle  
Manere tragatoare | 1

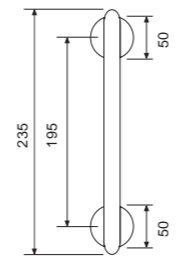

**DELTA**

**34502T - INOX SAT**  
Pull-handle  
Manere tragatoare | 1

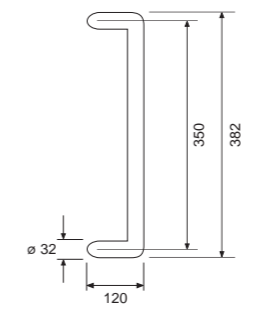

**GAMMA**

**34503T - INOX SAT**  
Pull-handle  
Manere tragatoare | 1

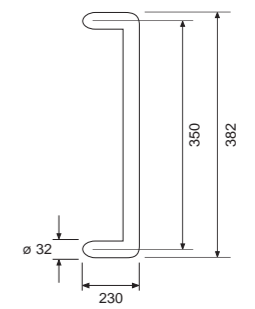



STAINLESS STEEL PULL-HANDLES  
 MANERE TRAGATOARE DIN OTEL INOXIDABIL

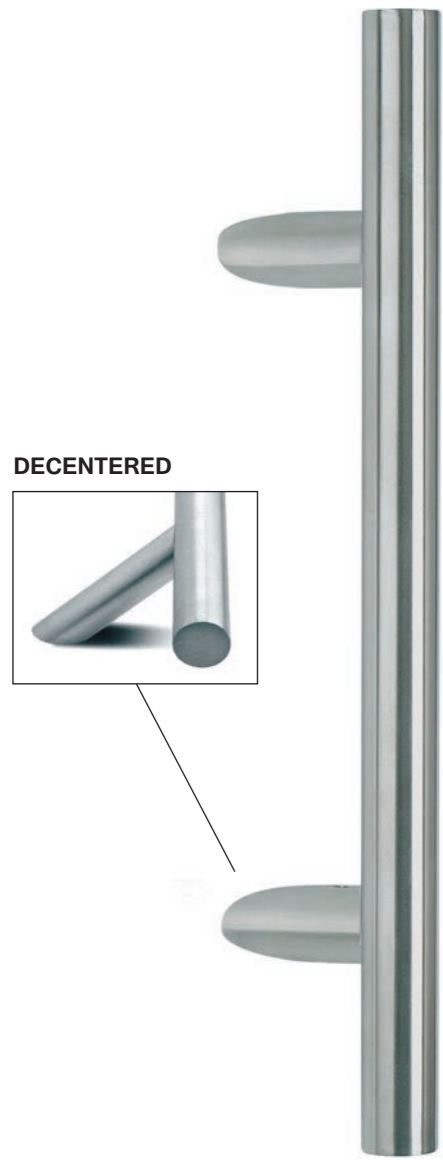

**THEMA**

34506T/D - INOX SAT

Pull-handle  
 Manere tragatoare | 1

	A	B	C	H
34506T/D	300	460	45	80
36506T/D	500	660	45	80
36116T/D	1000	1160	45	80

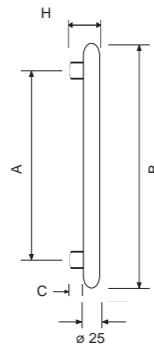

INOX SAT

**SIGMA**

34507T/D - INOX SAT

Pull-handle  
 Manere tragatoare | 1

	A	B
34507T/D	210	300
34507T/D	300	400
36507T/D	300	500
36507T/D	400	600
36517T/D	600	800
36517T/D	900	1200

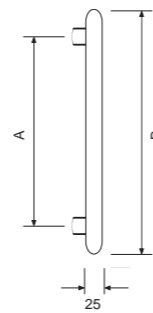

INOX SAT

**ROBY**

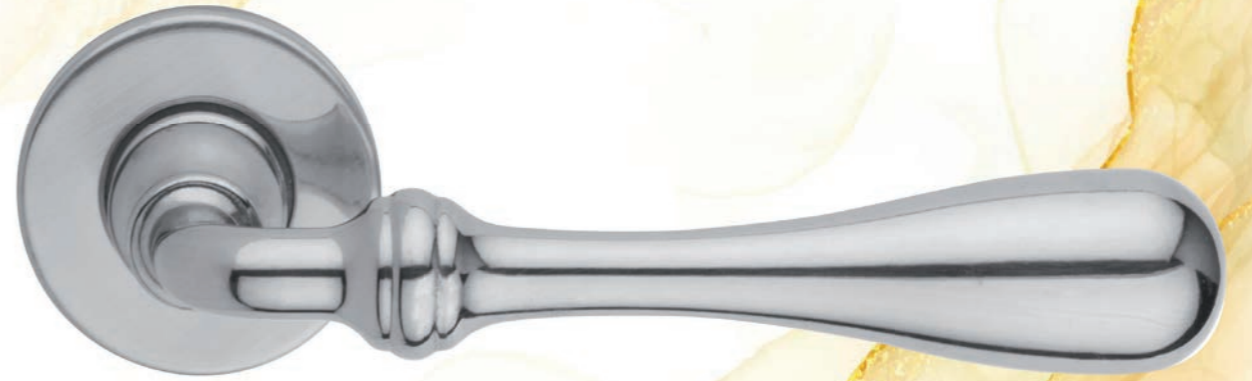

23087R07 - OC/OCS

Handle with rcv  
 Maner cu rozeta filetata

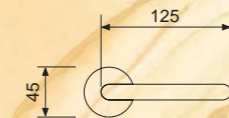



**MARGARET**



**23040R03 - ZCL/ZCS**



**23040R04 - ZCS**



**23040R04 - ZCL**



**MAREA**



**23062R04 - ZCS**  
Handle on rose  
*Maner cu rozeta*

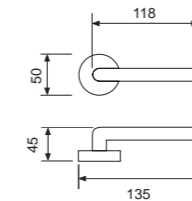

**33062DK - ZCS**  
Tilt and turn handle  
*DK*

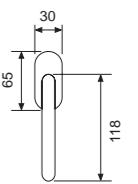

**CARINA**



**23066R04 - ZCS**  
Handle on rose  
*Maner cu rozeta*

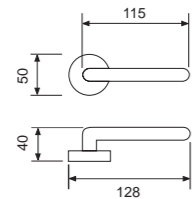

**23066PF - ZCS**  
Handle on plate  
*Maner cu placa*

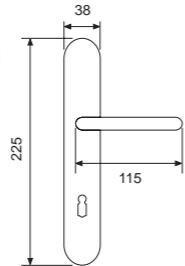

**33066DK - ZCS**  
Tilt and turn handle  
*DK*

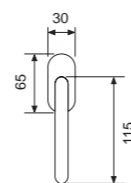

**MONICA**



**23050R04 - ZCS**  
Handle on rose  
*Maner cu rozeta*

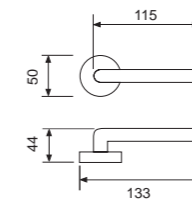

**33050DK - ZCS**  
Tilt and turn handle  
*DK*

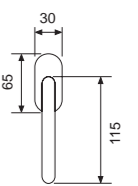



















**MURES**



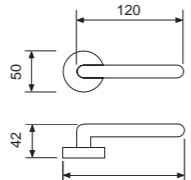

**25115R04 - F6**  
Handle on rose  
*Maner cu rozeta*





**25115P - F6**  
Handle on plate  
*Maner cu placa*

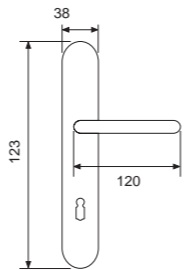



**25164P**

**25164P - RAL 9016**

Handle on plate	
Maner cu placa	25

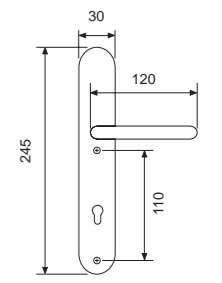



**ARAD**



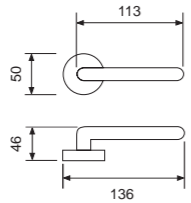

**25150R04 - F6**  
Handle on rose  
*Maner cu rozeta*





**25150P - F6**  
Handle on plate  
*Maner cu placa*

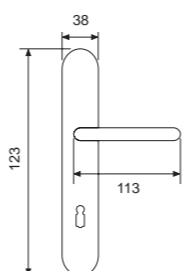



**25139R06**

**25139R06 - RAL 9016**

Handle on rose	
Maner cu rozeta	25

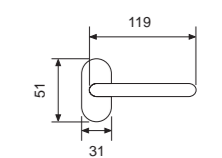



BRASS FIXED KNOBS  
BOTOANE FIX DIN ALAMA



**ELLE** INOX SAT



**24070R05 - INOX SAT**  
Handle on rose  
Maner cu rozeta

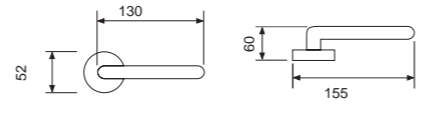

**NOVANTA** INOX SAT

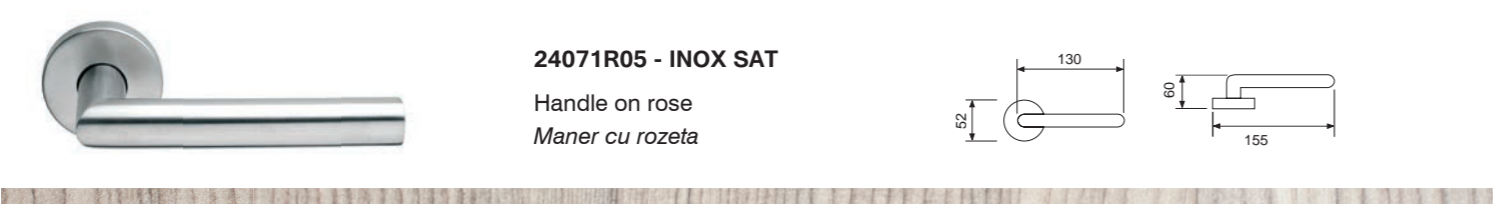

**24071R05 - INOX SAT**  
Handle on rose  
Maner cu rozeta

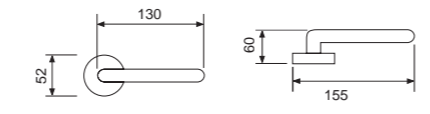

**U** INOX SAT

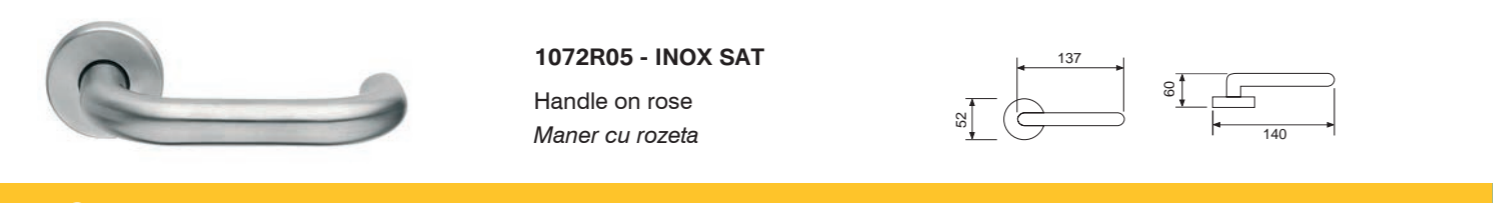

**1072R05 - INOX SAT**  
Handle on rose  
Maner cu rozeta

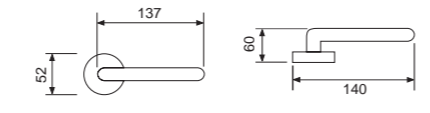

**BERLINO**

**33811R80 - ZOLV**  
Fixed door-knob  
Butoane fix

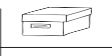

6

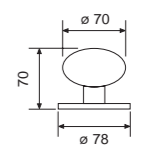

**33811R07 - ZOLV**  
Fixed door-knob  
Butoane fix

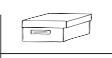

6

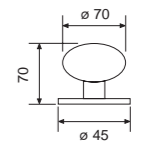

**VICTORIAN**

**31808R03 - OLV**  
Fixed door-knob  
Butoane fix

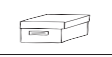

6

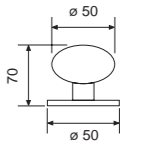



SERIA ACCESORII ACCESSORIES LINE

SERIA ACCESORII ACCESSORIES LINE



**PARIGI**

**33812R08 - ZCS**

Fixed door-knob

*Butoane fix*



6

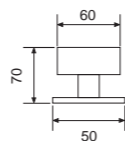

ZCL ZCS



**PARIGI DEC**

**33812R08/1 - ZCS**

Fixed door-knob

*Butoane fix*



6

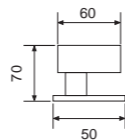

ZCL ZCS

**OLIVA**



**33815R04 - ZOL**

Knob on rose for opening limiting device

*Buton limitare deschidere usa*



30

ø 50 mm

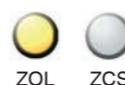

ZOL ZCS

**FRANCESE**



**33812R12 - ZCS**

Knob on rose for opening limiting device

*Buton limitare deschidere usa*



30

30x65 mm



ZCS

**NAPOLEONE**



**33814R12 - ZCS**

Knob on rose for opening limiting device

*Buton limitare deschidere usa*



30

30x65 mm



ZCS

**ELEGANT**

▶ page 36

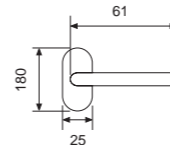

**31078OL - OLV**

Half handle on Oliver rose

*Oliver*



30

**AMBRA**

▶ page 34

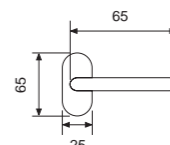

**31020OL - OLV**

Half handle on Oliver rose

*Oliver*



30

**GRANADA**

▶ page 33

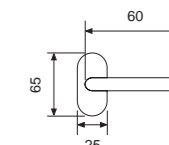

**31022OL - OLV**

Half handle on Oliver rose

*Oliver*



30

**WIEN**

▶ page 38

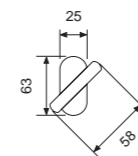

**31192S - OLV**

Window handle on Oliver rose

*Oliver T*



30

**WIEN**

▶ page 38

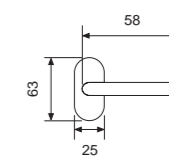

**31192OL - OLV**

Half handle on Oliver rose

*Oliver*



30



OLV OBG OCL OCS ONS



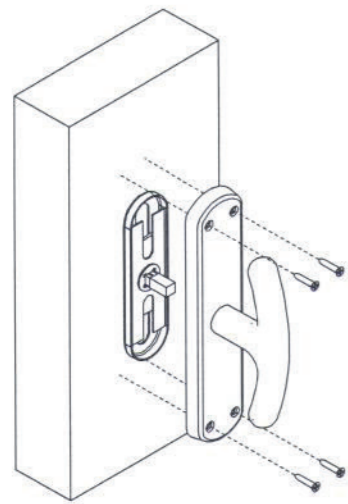

153x37 mm



170x36 mm



180x37 mm



153x37 mm

**ELEGANT**

▶ page 36

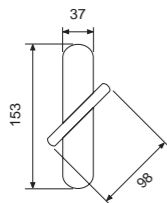

2078 - OLV

Window handle  
Cremon 12

**TOLOSA**

▶ page 23

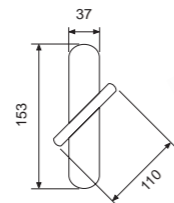

2058 - OGR

Window handle  
Cremon 12



**WIEN**

▶ page 38

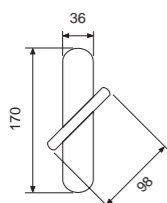

2092 - OLV

Window handle  
Cremon 12

**AMBRA**

▶ page 34

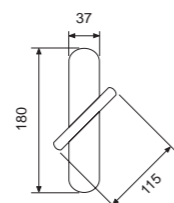

2020 - OLV

Window handle  
Cremon 12

**SIMONA**

▶ page 45

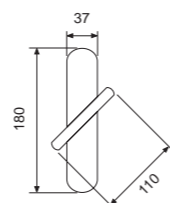

2046 - OLV

Window handle  
Cremon 12



**LEU**

31703 - OLV

Knocker  
Batatoare 25

180x120 mm



31704 - OLV

Knocker  
Batatoare 25

120x90 mm



4001 - OLV

Cover roller  
Role de acoperire 25

240x55 mm



4002 - OLV

Cover roller  
Role de acoperire 25

260x58 mm





DIFFERENT COMPLEMENTS  
DIFERITE COMPONENTE



31600L/2 - OLV

Small brass letters  
*Litere mici din alama* 25

50x38 mm



31600N/1 - OLV

Big brass numerals  
*Numere mari din alama* 25

125x73 mm



31600N/2 - OLV

Small brass numerals  
*Numere mici din alama* 25

75x40 mm



31601 - OLV

Doors stop  
*Opritoare usi* 150

ø 45 mm



31602 - OLV

Doors stop  
*Opritoare usi* 150

35x27 mm

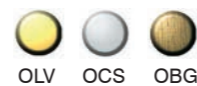

ROSES - TOILET ROSES - ESCUTHCEONS  
ROZETA - ROZETA WC - BOCHETTA

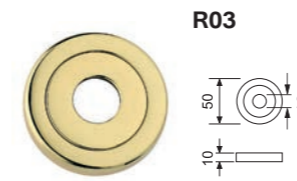

R03



B03P



B03Y



R03WC

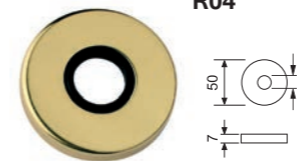

R04



B04BB



B04Y



R04WC

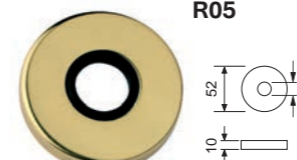

R05



B05P



B05Y



R05WC

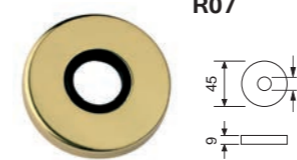

R07



B07P



B07Y



R07WC

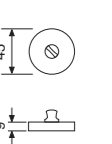

R07WC



ROSES - TOILET ROSES - ESCUTCHIONS  
 ROZETA - ROZETA WC - BOCHETTA

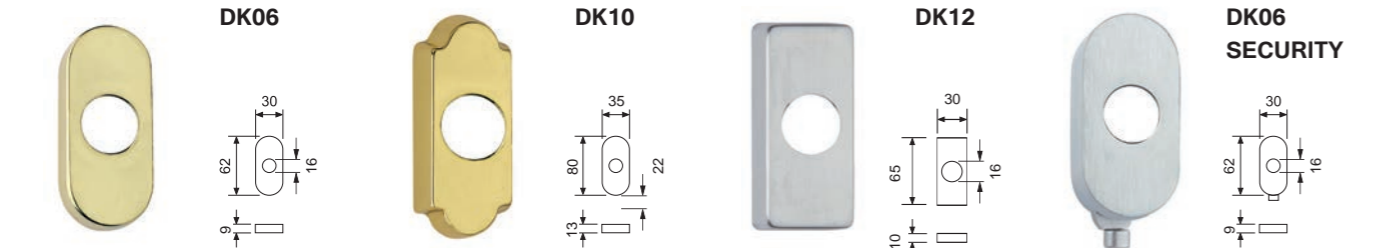
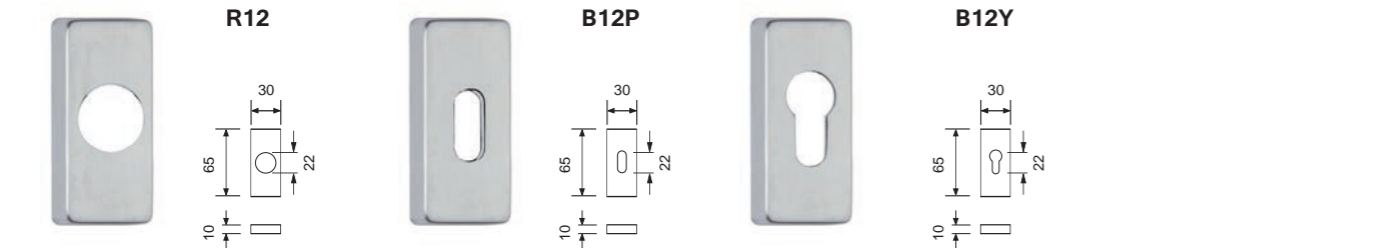
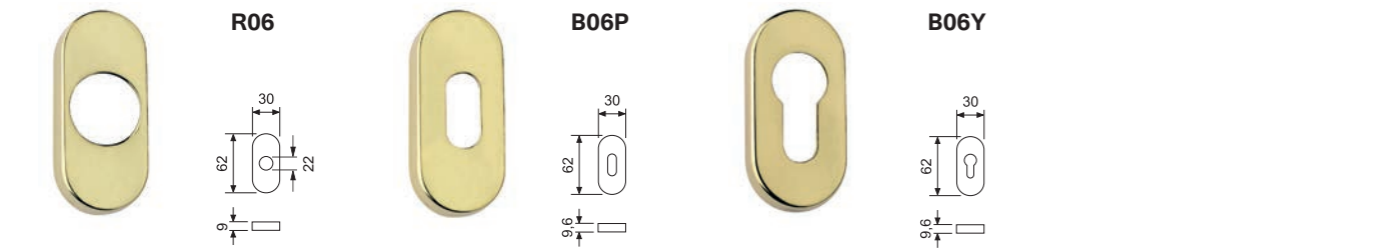
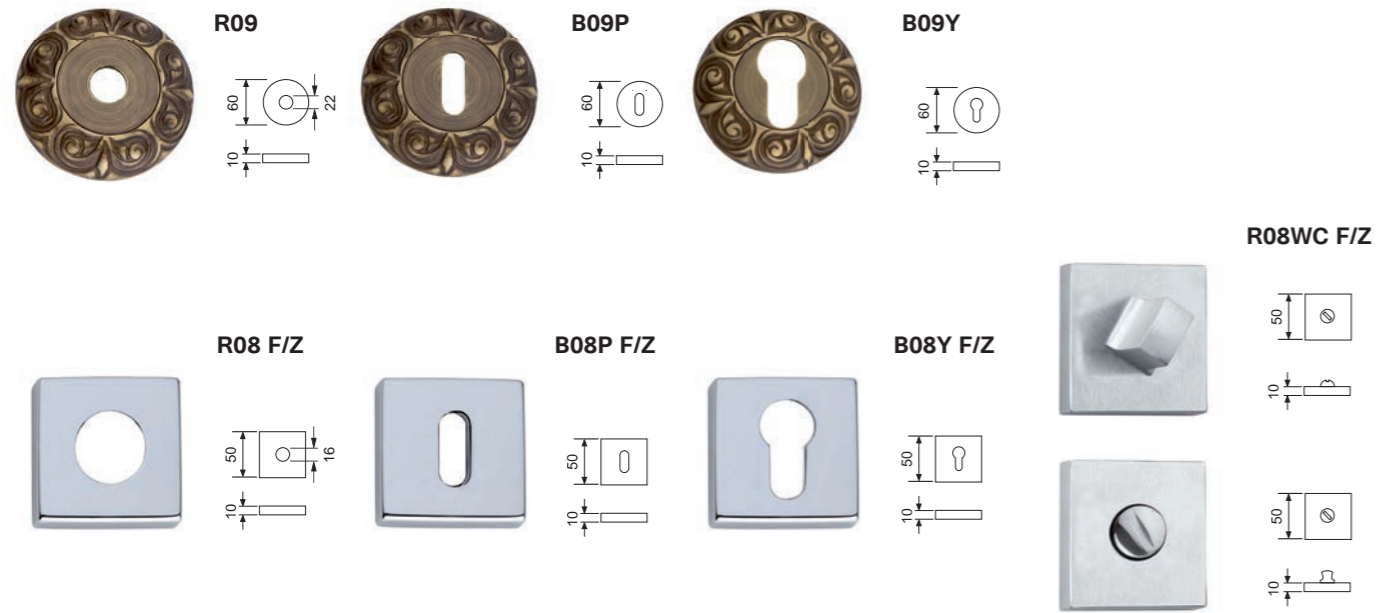

Cylinders and  
 Complements







VERO FER

BINALIA



A businessman is both a pioneer and an inventor, he acts with bravery, he is able to loose with dignity, but he is able to start again with enthusiasm.

Un om de afaceri este deopotrivă un pionier și un inventator, actionează cu curaj, este capabil să piardă cu demnitate, dar este întotdeauna în stare să reînceapă cu entuziasm.

**GIROLAMO VERCELLINI**  
*Founder Verofer srl*



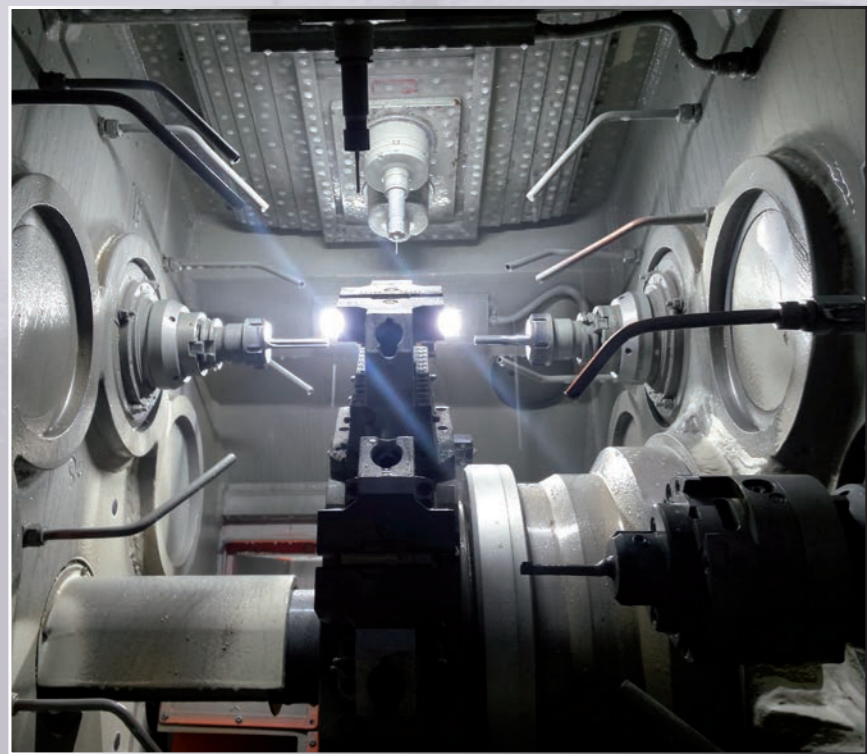
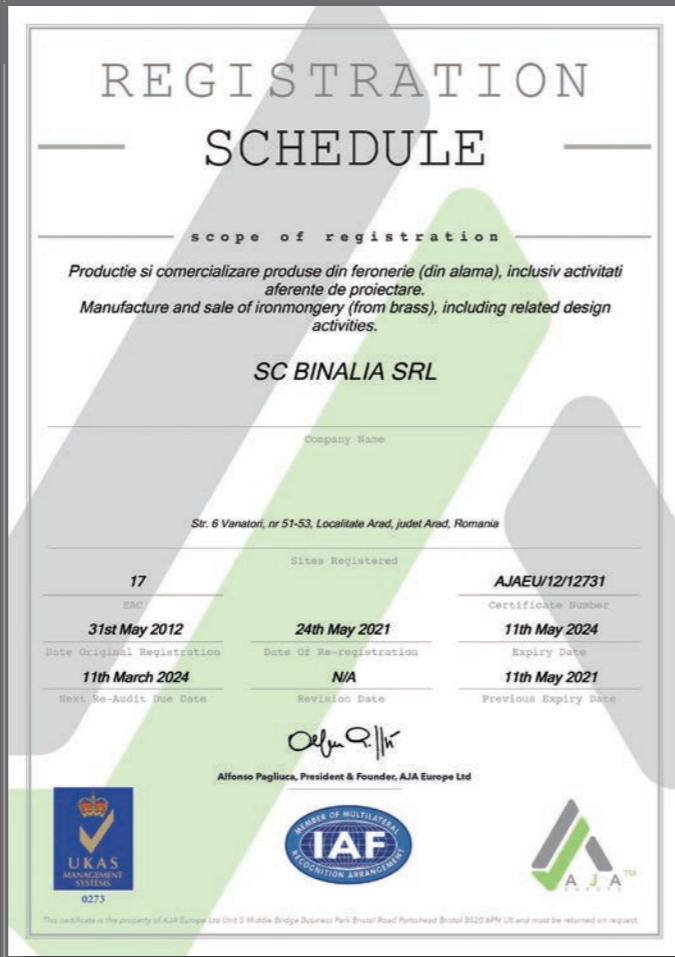

All our brass cylinders are produced under the UNI EN 1303 : 2015 - 07 norm  
Cilindri Verofer sunt realizati din alama respectand standardul UNI EN 1303 : 2015 - 07 norm





EUROPEAN PROFILE CYLINDERS  
CILINDRI PROFIL EUROPEAN



Cylinders are in brass supplied with:  
 . 3 brass nickel keys  
 . cam UNI or DIN  
 . fixing screw M 5x60

Cilindri sunt dotati cu:  
 . 3 chei din alama nichelate  
 . paleta UNI sau DIN  
 . surub M 5x60

Paleta UNI

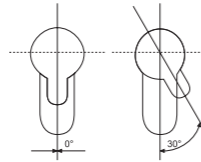

Paleta DIN

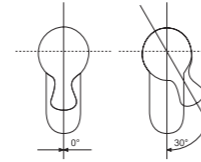

CODE <i>COD</i>	A	B	L	PINS <i>Nr. Stifturi</i>	1 PCS EACH BOX <i>Buc/cutie</i>	50 PCS EACH CARTON <i>Buc/bax</i>
	mm.					
110520	26	26	52	8	1	50
110561	26	30	56	8	1	50
110600	30	30	60	12/10	1	50
110601	25	35	60	8	1	50
110651	30	35	65	12/10	1	50
110700	35	35	70	12/10	1	50
110701	30	40	70	12/10	1	50
110751	35	40	75	12/10	1	50
110752	30	45	75	12/10	1	50
110800	40	40	80	12/10	1	50
110801	30	50	80	12/10	1	50
110802	35	45	80	12/10	1	50
110851	35	50	85	12/10	1	50
110852	40	45	85	12/10	1	50
110900	45	45	90	12/10	1	50
110901	35	55	90	12/10	1	50
110902	40	50	90	12/10	1	50
110903	30	60	90	12/10	1	50
110951	40	55	95	12/10	1	50
110952	45	50	95	12/10	1	50
110953	30	65	95	12/10	1	50
110954	35	60	95	12/10	1	50
111000	50	50	100	12/10	1	50
111001	45	55	100	12/10	1	50
111002	35	65	100	12/10	1	50
111051	45	60	105	12/10	1	50
111052	50	55	105	12/10	1	50
111101	45	65	110	12/10	1	50
111102	50	60	110	12/10	1	50
111151	50	65	115	12/10	1	50

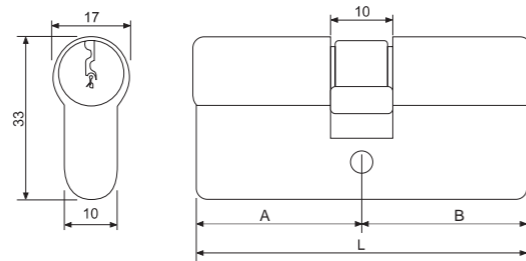

SECURITY CYLINDERS WITH REVERSIBLE KEYS  
CILINDRI DE SIGURANTA CU CHEI REVERSIBILE



Cylinders are in brass supplied with:  
 . 4 brass nickel keys  
 . cam UNI or DIN  
 . fixing screw M 5x60

Cilindri sunt dotati cu:  
 . 4 chei din alama nichelate  
 . paleta UNI sau DIN  
 . surub M 5x60

Paleta UNI

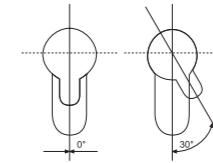

Paleta DIN

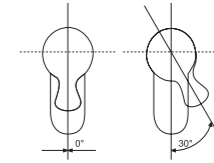

CODE <i>COD</i>	A	B	L	PINS <i>Nr. Stifturi</i>	1 PCS EACH BOX <i>Buc/cutie</i>	50 PCS EACH CARTON <i>Buc/bax</i>
	mm.					
110600A	30	30	60	12/10	1	50
110651A	30	35	65	12/10	1	50
110700A	35	35	70	12/10	1	50
110701A	30	40	70	12/10	1	50
110751A	35	40	75	12/10	1	50
110752A	30	45	75	12/10	1	50
110800A	40	40	80	12/10	1	50
110801A	30	50	80	12/10	1	50
110802A	35	45	80	12/10	1	50
110851A	35	50	85	12/10	1	50
110852A	40	45	85	12/10	1	50
110900A	45	45	90	12/10	1	50
110901A	35	55	90	12/10	1	50
110902A	40	50	90	12/10	1	50
110903A	30	60	90	12/10	1	50
110951A	40	55	95	12/10	1	50
110952A	45	50	95	12/10	1	50
111000A	50	50	100	12/10	1	50
111001A	45	55	100	12/10	1	50
111051A	45	60	105	12/10	1	50
111052A	50	55	105	12/10	1	50
111102A	50	60	110	12/10	1	50

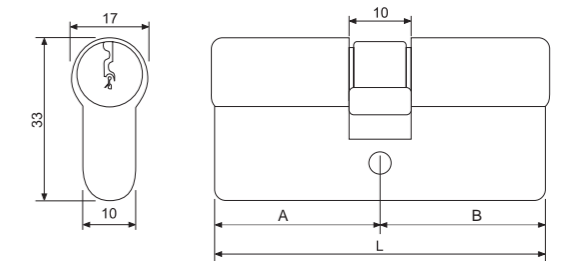





**BATHROOM CYLINDERS & THUMBTURN**  
**CILINDRI CU BUTON PENTRU BAIE**



Cylinders are in brass supplied with:  
 . cam UNI or DIN  
 . fixing screw M 5x60

Cilindri sunt dotati cu:  
 . paleta UNI sau DIN  
 . surub M 5x60

**Paleta UNI**

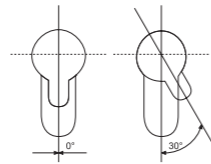

**Paleta DIN**

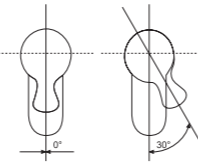

CODE <i>COD</i>	A	B mm.	L	PINS <i>Nr. Stifturi</i>	1 PCS EACH BOX <i>Buc/cutie</i>	50 PCS EACH CARTON <i>Buc/bax</i>
110520W	26	26	52	-	1	50
110561WL	26	30	56	-	1	50
110561WS	30	26	56	-	1	50
110600W	30	30	60	-	1	50
110601WL	25	35	60	-	1	50
110601WS	35	25	60	-	1	50
110651WL	30	35	65	-	1	50
110651WS	35	30	65	-	1	50
110700W	35	35	70	-	1	50
110701WL	30	40	70	-	1	50
110701WS	40	30	70	-	1	50
110751WL	35	40	75	-	1	50
110751WS	40	35	75	-	1	50
110800W	40	40	80	-	1	50
110801WL	30	50	80	-	1	50
110801WS	50	30	80	-	1	50
110802WL	35	45	80	-	1	50
110802WS	45	35	80	-	1	50
110851WL	35	50	85	-	1	50
110851WS	50	35	85	-	1	50
110852WL	40	45	85	-	1	50
110852WS	45	40	85	-	1	50
110900W	45	45	90	-	1	50
110901WL	35	55	90	-	1	50
110901WS	55	35	90	-	1	50
110902WL	40	50	90	-	1	50
110902WS	50	40	90	-	1	50
110951WL	40	55	95	-	1	50
110951WS	55	40	95	-	1	50
110952WL	45	50	95	-	1	50
110952WS	50	45	95	-	1	50
111000W	50	50	100	-	1	50
111001WL	45	55	100	-	1	50
111001WS	55	45	100	-	1	50
111051WL	45	60	105	-	1	50
111051WS	60	45	105	-	1	50
111101WS	65	45	110	-	1	50
111102WL	50	60	110	-	1	50
111102WS	60	50	110	-	1	50

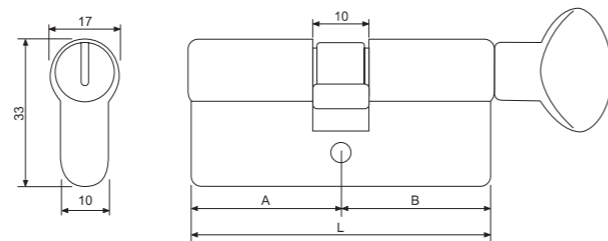

**CYLINDERS WITH THUMBTURN & 3 KEYS**  
**CILINDRI CU BUTON & CHEI**



Cylinders are in brass supplied with:  
 . 3 brass nickel keys  
 . cam UNI or DIN  
 . fixing screw M 5x60

Cilindri sunt dotati cu:  
 . 3 chei din alama nichelate  
 . paleta UNI sau DIN  
 . surub M 5x60

**Paleta UNI**

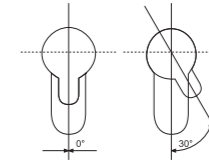

**Paleta DIN**

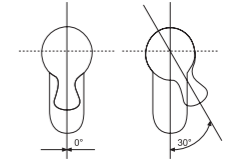

CODE <i>COD</i>	A	B mm.	L	PINS <i>Nr. Stifturi</i>	1 PCS EACH BOX <i>Buc/cutie</i>	50 PCS EACH CARTON <i>Buc/bax</i>
110520B	26	26	52	4	1	50
110561BL	26	30	56	4	1	50
110561BS	30	26	56	4	1	50
110600B	30	30	60	5	1	50
110601BL	25	35	60	4	1	50
110601BS	35	25	60	5	1	50
110651BL	30	35	65	5	1	50
110651BS	35	30	65	5	1	50
110700B	35	35	70	5	1	50
110701BL	30	40	70	5	1	50
110701BS	40	30	70	5	1	50
110751BL	35	40	75	5	1	50
110751BS	40	35	75	5	1	50
110800B	40	40	80	5	1	50
110801BL	30	50	80	5	1	50
110801BS	50	30	80	5	1	50
110802BL	35	45	80	5	1	50
110802BS	45	35	80	5	1	50
110851BL	35	50	85	5	1	50
110851BS	50	35	85	5	1	50
110852BL	40	45	85	5	1	50
110852BS	45	40	85	5	1	50
110900B	45	45	90	5	1	50
110901BL	35	55	90	5	1	50
110901BS	55	35	90	5	1	50
110902BL	40	50	90	5	1	50
110902BS	50	40	90	5	1	50
110951BL	40	55	95	5	1	50
110951BS	55	40	95	5	1	50
110952BL	45	50	95	5	1	50
110952BS	50	45	95	5	1	50
111000B	50	50	100	5	1	50
111001BL	45	55	100	5	1	50
111001BS	55	45	100	5	1	50
111051BL	45	60	105	5	1	50
111051BS	60	45	105	5	1	50
111102BL	50	60	110	5	1	50
111102BS	60	50	110	5	1	50

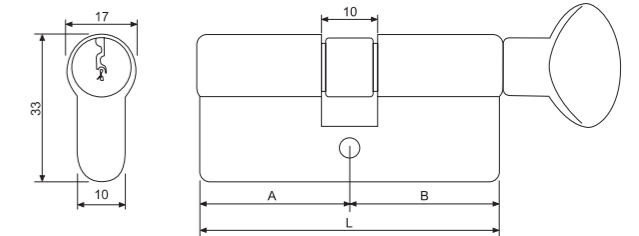





**SINGLE CYLINDERS & THUMBTURN**  
**SEMICILINDRI CU BUTON**



Cylinders are in brass supplied with:  
 . cam UNI or *DIN*  
 . fixing screw M 5x60

*Cilindri sunt dotati cu:*  
 . paleta UNI sau DIN  
 . surub M 5x60

**Paleta UNI**

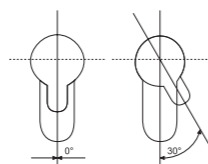

**Paleta DIN**

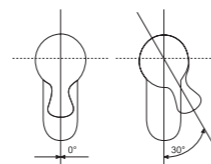

CODE <i>COD</i>	A	B	L	PINS <i>Nr. Stifturi</i>	1 PCS EACH BOX <i>Buc/cutie</i>	100 PCS EACH CARTON <i>Buc/bax</i>
110401BL	10	30	40	-	1	50
110451BL	10	35	45	-	1	50
110501BL	10	40	50	-	1	50

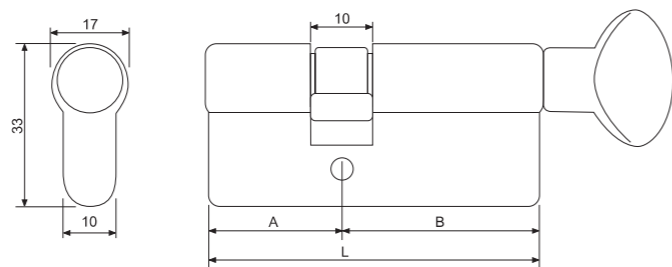

**SINGLE CYLINDERS & KEYS**  
**SEMICILINDRI & CHEI**



Cylinders are in brass supplied with:  
 . 3 brass nickel keys  
 . cam UNI or *DIN*  
 . fixing screw M 5x60

*Cilindri sunt dotati cu:*  
 . 3 chei din alama nichelate  
 . paleta UNI sau DIN  
 . surub M 5x60

**Paleta UNI**

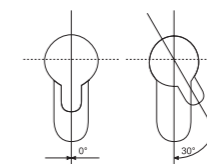

**Paleta DIN**

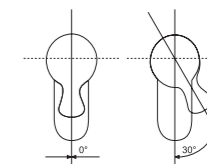

CODE <i>COD</i>	A	B	L	PINS <i>Nr. Stifturi</i>	1 PCS EACH BOX <i>Buc/cutie</i>	100 PCS EACH CARTON <i>Buc/bax</i>
110351	10	25	35	4	1	50
110401	10	30	40	5	1	50
110451	10	35	45	5	1	50
110501	10	40	50	5	1	50

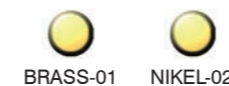
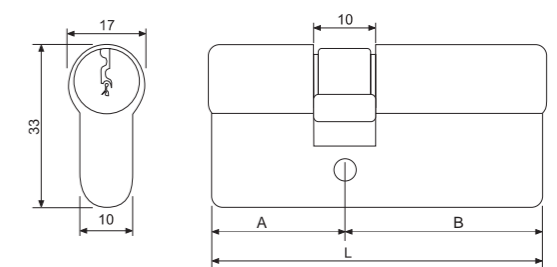





Master key

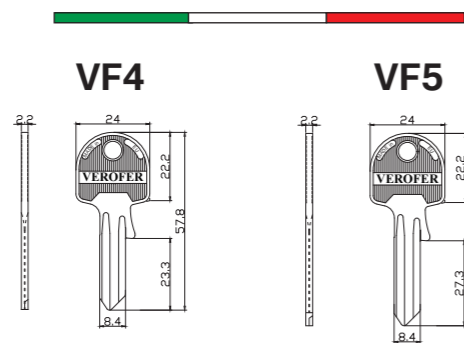
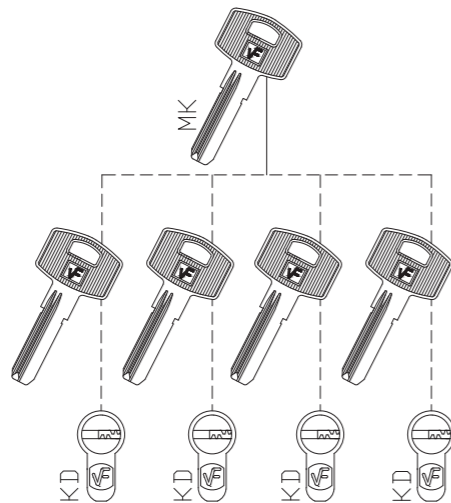

CODE <i>COD</i>	A	B mm.	L	PINS <i>Nr. Stifturi</i>	1 PCS EACH BOX <i>Buc/cutie</i>
110600_MK	30	30	60	12	1
110651_MK	30	35	65	12	1
110700_MK	35	35	70	12	1
110701_MK	30	40	70	12	1
110800_MK	40	40	80	12	1
110802_MK	35	45	80	12	1
110852_MK	40	45	85	12	1
110900_MK	45	45	90	12	1
110902_MK	40	50	90	12	1
110951_MK	40	55	95	12	1
110952_MK	45	50	95	12	1



Construction/definitive keys  
Cheie de constructie/definitiva

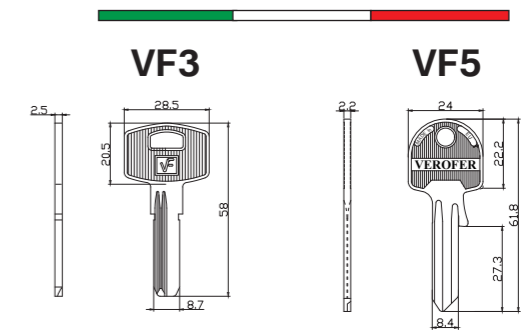
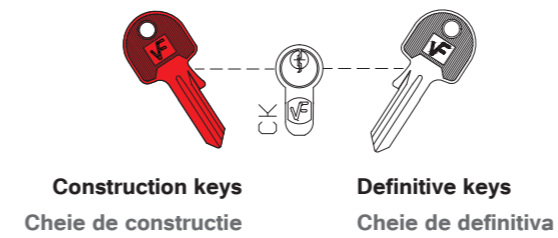

Keys  
*Cheie*

CODE <i>COD</i>	A	B mm.	L	PINS <i>Nr. Stifturi</i>	1 PCS EACH BOX <i>Buc/cutie</i>
110600_CC	30	30	60	10	1
110651_CC	30	35	65	10	1
110700_CC	35	35	70	10	1
110701_CC	30	40	70	10	1
110800_CC	40	40	80	10	1
110802_CC	35	45	80	10	1
110852_CC	40	45	85	10	1
110900_CC	45	45	90	10	1
110902_CC	40	50	90	10	1
110951_CC	40	55	95	10	1
110952_CC	45	50	95	10	1

Thumbturn  
*Buton*

CODE <i>COD</i>	A	B mm.	L	PINS <i>Nr. Stifturi</i>	1 PCS EACH BOX <i>Buc/cutie</i>
110600B_CC	30	30	60	5	1
110651BL_CC	30	35	65	5	1
110700B_CC	35	35	70	5	1
110701BL_CC	30	40	70	5	1
110800B_CC	40	40	80	5	1
110802BL_CC	35	45	80	5	1
110852BL_CC	40	45	85	5	1
110900B_CC	45	45	90	5	1
110902BL_CC	40	50	90	5	1
110951BL_CC	40	55	95	5	1
110952BL_CC	45	50	95	5	1





**Emergency function**  
**Cilindru cu functia de urgenta**

Cylinders are in brass supplied with:  
 . brass nichel keys  
 . cam UNI or DIN  
 . fixing screw M 5x60

Cilindri sunt dotati cu:  
 . chei din alama nichelate  
 . paleta UNI sau DIN  
 . surub M 5x60

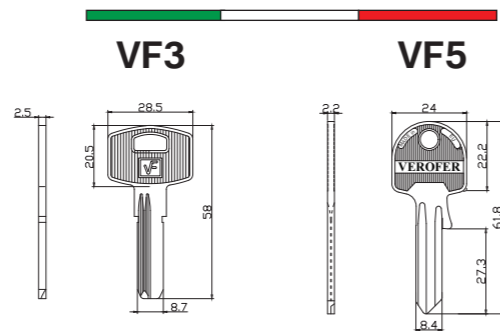
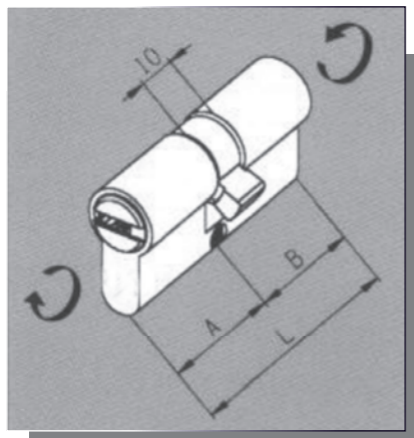

CODE <i>COD</i>	A	B mm.	L	PINS <i>Nr. Stifturi</i>	1 PCS EACH BOX <i>Buc/cutie</i>
110600_DF	30	30	60	5	1
110651_DF	30	35	65	5	1
110700_DF	35	35	70	5	1
110701_DF	30	40	70	5	1
110800_DF	40	40	80	5	1
110802_DF	35	45	80	5	1
110852_DF	40	45	85	5	1
110900_DF	45	45	90	5	1
110902_DF	40	50	90	5	1
110951_DF	40	55	95	5	1
110952_DF	45	50	95	5	1

**Cylinder for thumbturn**  
**Cilindru pt buton**

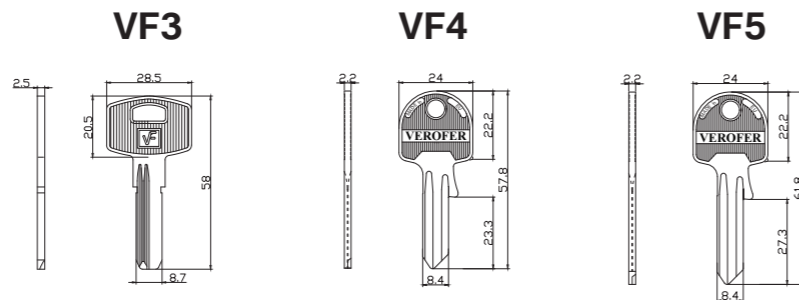
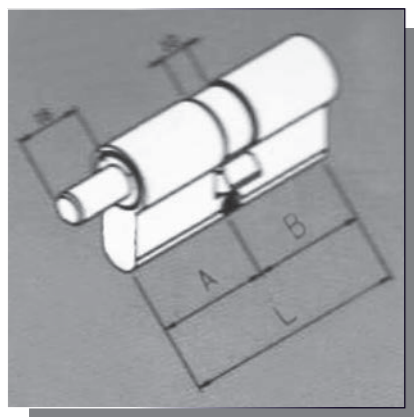

**Paleta UNI**

**Paleta DIN**

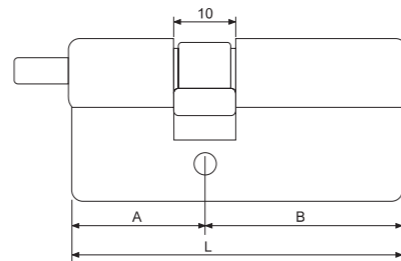
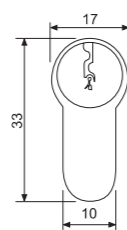
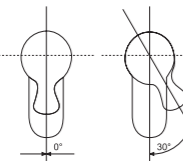
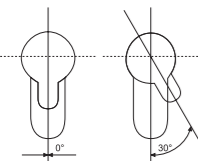

**Individual keys**  
**Cheie individuale**

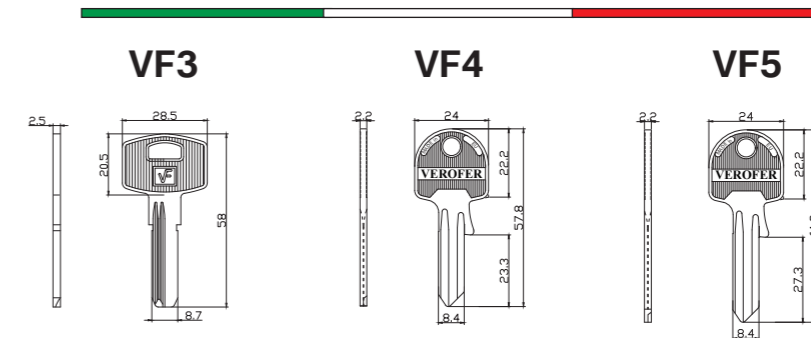
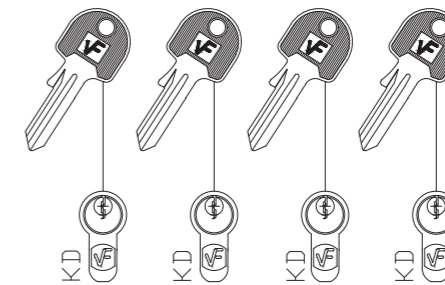

**Same keys**  
**Aceiasi cheie**

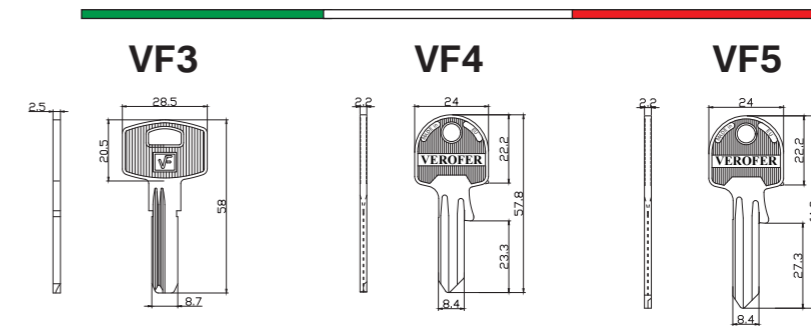
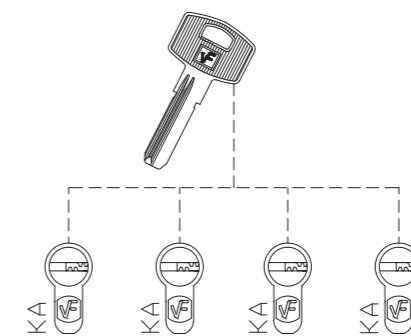





035-199

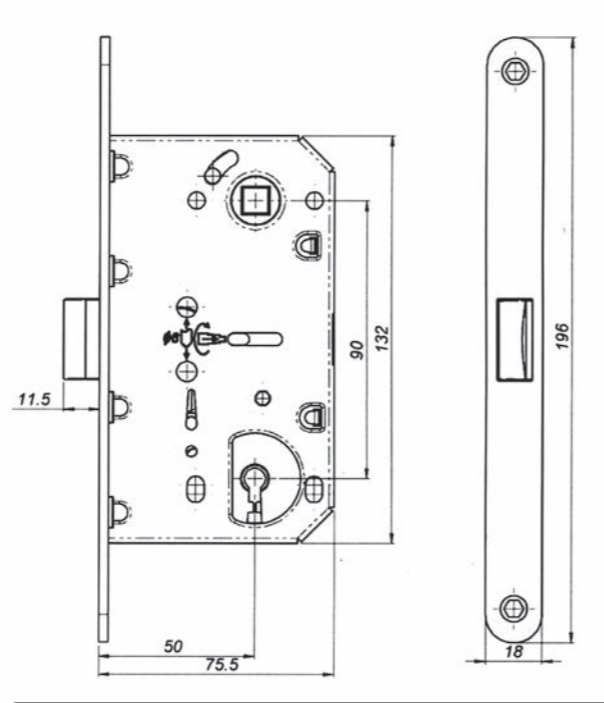

035-29

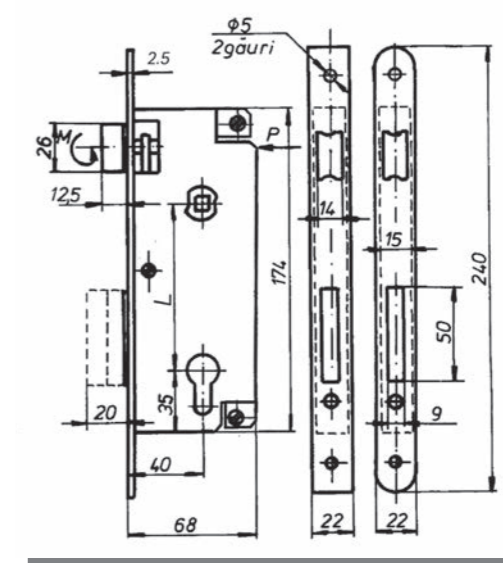

Cod. produs	Tip	Characteristics	L	A	Finishing	Packing	Striking Plate
035-199	P		90	A50	ZCS	50	035-204
035-200	Y	DIN	85				035-207
035-201	WC	Q 6	96				035-210

Cod. produs	Tip	Characteristics	L	A	Finishing	Packing	Striking Plate
035-32	P		90	A40	PAINTED ZOLV+P	20/1	035-59
035-29	Y	UNI	85				
035-18	Y		85				
035-89	WC	Q.8	90				

The door lock is reversible. The door latch could be retreated also by using the key.  
Broasca este reversibila. Limba broastei se poate retrage si din cheie.

The door lock is reversible. In case of Y type the door latch could be retreated also by using the key.  
Broasca este reversibila. La varianta Y limba broastei se poate retrage si din cheie.





035-154

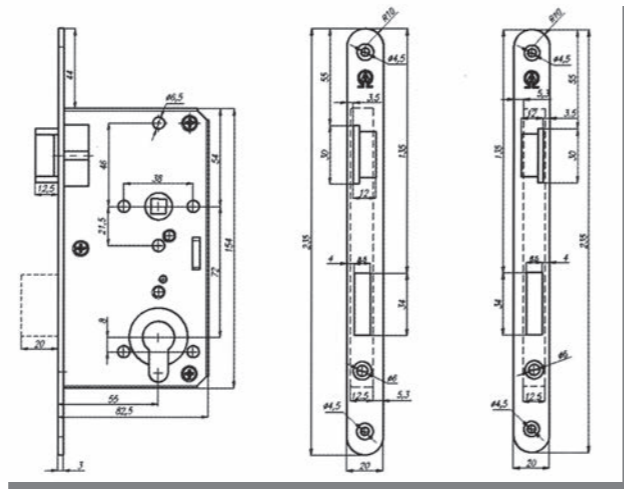

035-174

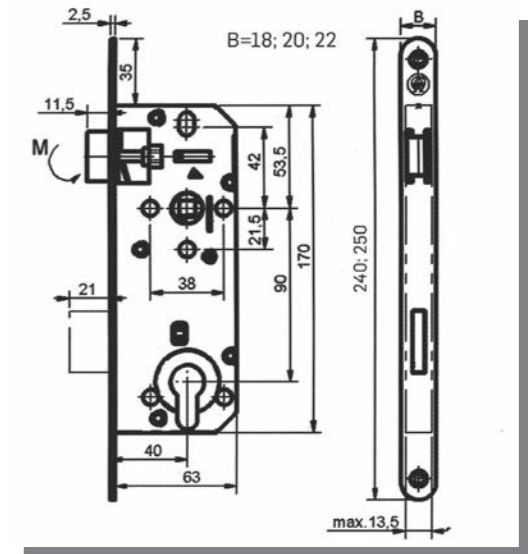

Cod. produs	Tip	Characteristics	L	A	Finishing	Packing	Striking Plate
035-154	P left		72	A55	PAINTED+ NATUR	20/01	035-183
035-155	P right						
035-186	P						
035-150	Y left						
035-151	Y right						
035-187	Y						
035-152	WC left	Q.6,8	72				
035-153	WC right		78				
035-188	WC		78				

Cod. produs	Tip	Characteristics	L	A	Finishing	Packing	Striking Plate
035-174	P		90	A40	ZI	20/01	035-178
035-181				A50			
035-175				A40	ZA		
035-182	Y	A50					
035-177		DIN	85	A40	PAINTED+ NATUR		
035-180	WC	Q.6,8	90	A40			
035-184				A50			

The door lock is not reversible. In case of Y type the door latch could be retreated also by using the key.  
Broasca nu este reversibila. La varianta Y limba broastei se poate retrage si din cheie.

The door lock is reversible. In case of 035-182 type the door latch could be retreated also by using the key.  
Broasca este reversibila. La varianta 035-182 limba broastei se poate retrage si din cheie.





LOCKS FOR ALUMINIUM DOORS  
BROASTE PENTRU USI DIN ALUMINIU



035-91

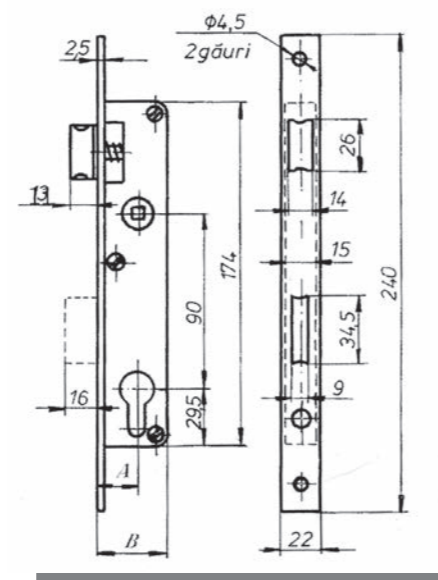

Cod. produs	Tip	Characteristics	L	A	Finishing	Packing	Striking Plate
035-92	Y		92	A35	NIK+ZA	20/1	035-122
035-91			85	A35			
035-108			92	A30			
035-106			85	A30			
035-115			92	A25			
035-113			85	A25			
			DIN				

The door lock is reversible. The door latch could be retreated also by using the key.  
Broasca este reversibila. Limba broastei se poate retrage si din cheie.



LOCKS FOR PVC DOORS  
BROASTE PENTRU USI DIN PVC



035-96

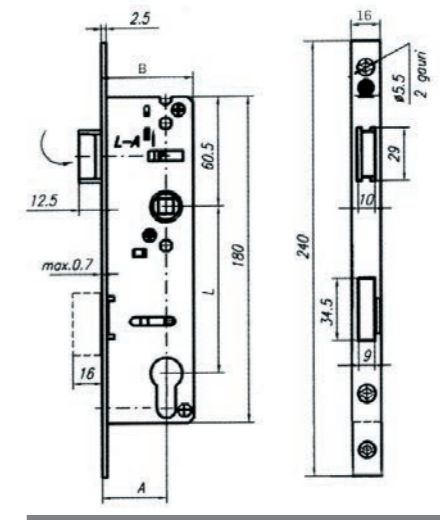

Cod. produs	Tip	Characteristics	L	A	Finishing	Packing	Striking Plate
035-96	Y		92	A35	NIK+ZA	20/1	035-171L 035-172 R
035-95			85	A35			
035-111			92	A30			
035-109			85	A30			
035-123			92	A25			
035-118			85	A25			
035-158			85	A20			
			DIN				

The door lock is reversible. The door latch could be retreated also by using the key.  
Broasca este reversibila. Limba broastei se poate retrage si din cheie.





STRIKING PLATES  
CONTRA PLACI



**035-59 - OP**

Striking plates  
Contra placi

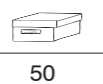

50

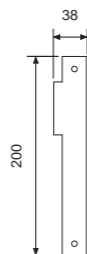

**035-171L - ZA**

Striking plates  
Contra placi



50

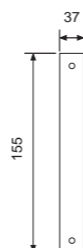

**035-183 - ZA**

Striking plates  
Contra placi



50



STRIKING PLATES  
CONTRO PLACI



**035-204 - CRS**

Striking plates  
Contra placi



50

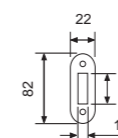

**035-210 - CRS**

Striking plates  
Contra placi



50

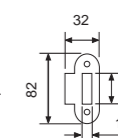

**035-178 - CMR**

Striking plates  
Contra placi



50



**035-207 - CMR**

Striking plates  
Contra placi



50

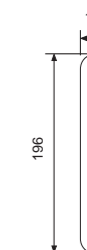





**035-200S - OL**

Sliding-door wc lock with striking plate

Broasca baie pentru usi glisante cu tablita

20

A	B	C	D
50	16	70	100

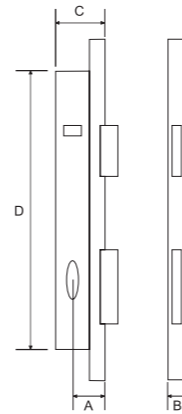

**035-201S - OL**

sliding-door wc lock with striking plate

broasca baie pentru usi glisante cu tablita

20

A	B	C	D
50	16	70	100

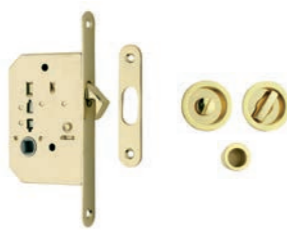
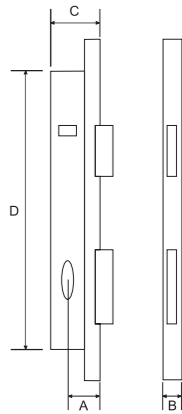

**035-200SR - OL**

kit of sliding-door wc lock with inset handles and striking plate

Set broasca baie cu tablita, manere si element tragere pentru usi glisanteusi

20



**035-201SR - OL**

kit of sliding-door patent lock with inset handles and striking plate

Set broasca cu tablita, manere si element tragere pentru usi glisante

20



**316032P - OL**

Pair of inset wc-handles with pull flush

Set manere ovale baie pentru usi glisante cu elem.tragere

20

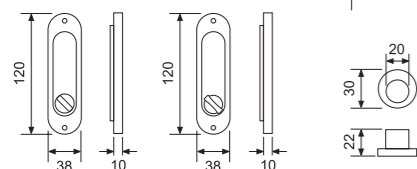

**316032R - OL**

**316039R - OL**

Pair of inset wc-handles with pull flush

Set manere rotunde baie pentru usi glisante cu elem.tragere

20

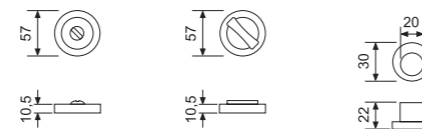

**316031P - OL**

Pair of inset wc-handles with pull flush

Set manere ovale cheie pentru usi glisante cu elem.tragere

20

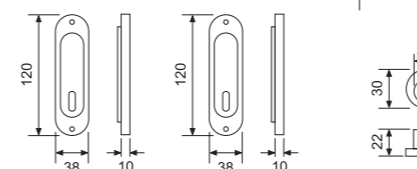

**316031R - OL**

Pair of inset wc-handles with pull flush

set manere rotunde cheie pentru usi glisante cu elem.tragere

20

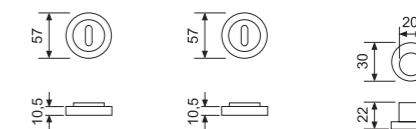





**035-200S - CS**

Sliding-door wc lock  
with striking plate

*Broasca baie pentru  
usi glisante cu tablita*



20

A	B	C	D
50	16	70	100

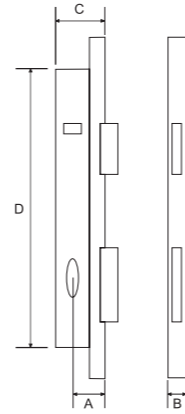

**035-200SQ - CS**

Kit of sliding-door wc lock  
with inset handles and striking plate

*Set broasca baie cu tablita, manere  
si element tragere pentru usi glisante*



20



316032Q - CS

316039Q - CS

Pair of inset  
wc-handles

*Set manere rotunde  
baie pentru usi glisante*



20

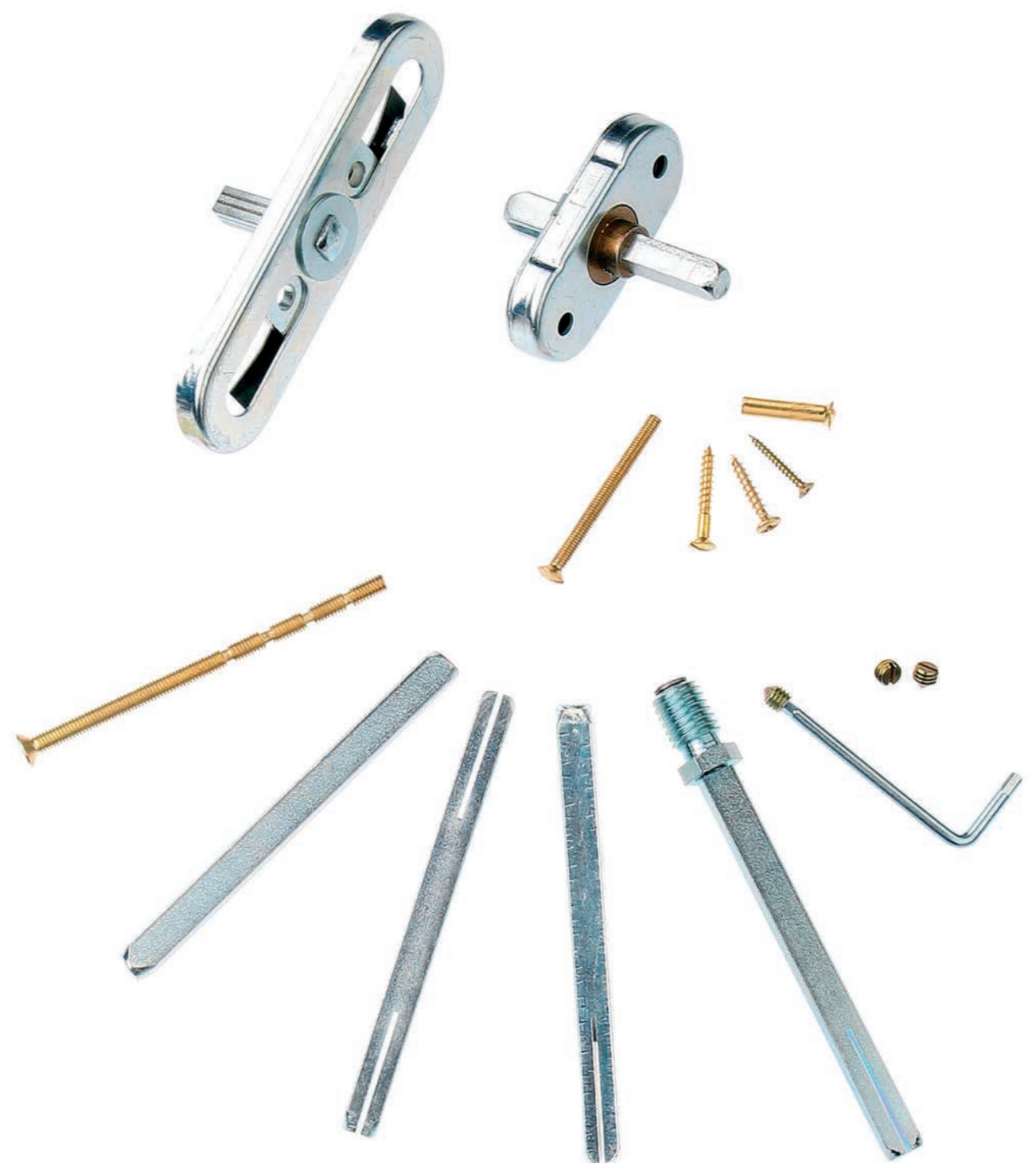
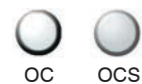
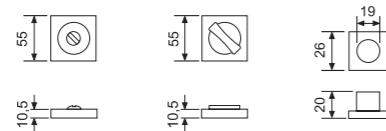



## GENERAL SALES RULES

### ORDERS

The following sales conditions rule over all the orders accepted by SC VEROFER SRL.

### TRANSPORT

The transport company assumes its responsibility for all the risks and all the threats that occurs during the transport process even if our company organises the spediton directly to our customers by using a third transport company. SC VEROFER SRL does not assume its responsibility for eventual delays caused by the transport companies.

### CLAIMS

In case of eventual claims our company must be informed in maximum 10 days after the checking on delivery.

We do not accept returns of the goods that were delivered according to the original order that we received from our customer. In any case when a client want to return a quantity of goods, the list of the goods to be returned must be accepted in advance by SC VEROFER SRL.

### GUARANTEE

With the present SC VEROFER SRL guarantees that all its production programe is controled against the vices of production process. This mentioned guarantee is limited to the duty of SC VEROFER SRL to replace the goods that it recognize as having deficiencies without any other responsibility.

### TERMS OF DELIVERY

The eventual delays in delivery do not give to our customers the right to pretend any reparation.

### PRODUCT

The information contained inside this catalogue is aproximate.

SC VEROFER SRL reserves his rights to improve the characteristics of its goods relative to the continue technical evolution.

### DISPUTES

Any eventual dispute concerning the delivered goods or concerning our agreement will be judged by the instance court of ARAD.

## CONDITII GENERALE DE VANZARE

### COMENZI

Condițiile prezentate mai jos se aplică tuturor comenzilor acceptate de către SC VEROFER SRL.

### TRANSPORT

Transportatorul răspunde pentru eventualele riscuri și pericole survenite pe parcursul transportului chiar și atunci când expedierea este făcută de către firma noastră la adresa beneficiarului prin intermediul unui terț transportator.

SC VEROFER SRL nu răspunde pentru întârzierile la livrare datorate transportatorilor.

### EVENTUALE RECLAMAȚII

Eventualele reclamații trebuie transmise în scris în cel mult 10 zile de la recepționarea mărfii de către beneficiar.

Nu se acceptă restituiri de marfă atunci când livrarea a fost făcută de către furnizor conform comenzii inițiale a beneficiarului. In orice situație în care se dorește efectuarea unui retur de marfă, lista cu produsele returnate trebuie acceptată în prealabil de către SC VEROFER SRL.

### GARANȚII

SC VEROFER SRL garantează pe această cale că toate produsele realizate sunt verificate împotriva viciilor ce pot surveni pe parcursul procesului de producție.

Garanția anterior menționată se exercită prin înlocuirea produsului recunoscut de către noi ca fiind defect fără a atrage în astfel de cazuri acordarea unor eventuale despăgubiri.

### TERMENE DE LIVRARE

SC VEROFER SRL nu acordă garanții generale de nici o natură în ceea ce privește termenele de livrare. Eventualele întârzieri nu conferă dreptul beneficiarului de a pretinde despăgubiri indiferent de natura acestora.

### PRODUS

Informațiile conținute în acest catalog sunt furnizate cu titlu informativ.

SC VEROFER SRL își rezervă dreptul de a ameliora fără preaviz caracteristicile produselor sale în funcție de permanenta evoluție tehnologică.

### LITIGII

Soluționarea tuturor eventualelor litigii referitoare la marfă sau la contractul de colaborare este de competența instanței judecătorești din Arad.



**The companies Binalia - Verofer** reserve the right to change products specifications without prior notice. Descriptions, photos, colours and product sizes are not binding.

**Comaniile Verofer si Binalia** isi rezerva dreptul de a actualiza specificatiile tehnice din prezentul catalog fara o informare in prealabil.



MADE IN EU



